

GATBO[®]



**From Kitchen to Table,
Safe Storage Every Step of the Way.**



GATBO is committed to combining the craftsmanship of German technology with the practical needs of the catering industry to create plastic products that are versatile, practical and durable.

In the usage scenarios of food storage, preparation, delivery, enjoyment, and cleaning, GATBO provides a full range of solutions, so that every food service can be presented safely.



GATBO, Your Best Choice.

National Industrial Quality Benchmark



International Authoritative Guarantees



A quality management system standard formulated by the International Organization for Standardization (ISO)



Issued by NSF, an authoritative institution in the field of public health and safety, which has been adopted as the national standard by the American National Standards Institute (ANSI) and the Standards Council of Canada (SCC).



Third-party PFAS testing with compliance certification issued.



European Union certification. Products need to pass the testing and evaluation of the EU standardization body and obtain the relevant certificate before entering the European market.



A quality management system standard formulated by the International Organization for Standardization (ISO)



United States Food and Drug Administration, Products approved by the FDA are safe and effective for the human body



Hazard Analysis and Critical Control Point Management System Certification. The National Academy of Sciences and the WHO/FAO Committee on Nutrition Law agree that HACCP is the most effective management system for ensuring food safety



A quality management system standard formulated by the International Organization for Standardization (ISO)



A quality management system standard formulated by the International Organization for Standardization (ISO)



Mandatory standards set by EU legislation



Registration certification of the European Chemicals Agency (ECHA)



Global certification of social responsibility

300+ Patents



FIVE MAJOR SERIES

Storage

FOOD PANS(US)P5-P6



LID(US)P7-P9



COLANDER PANS(US)P9-P11



DRAIN SHELF(US) P12



FOOD PANS(EU)P13-14、 P17



LID(EU)P15-P17



COLANDER PANS(EU) P18-P19



DRAIN SHELF(EU)P20



HIGH HEAT FOOD PANS P21



S/S FOOD PANS P22-P24



FOOD PANS AND LIDS P25



SQUARE FOOD CONTAINER P30



ROUND FOOD CONTAINERS P31-P32



FOOD STORAGE BOXES P33



CROCK P34



SQUARE FOOD CONTAINER P34



CROCK WITH PUMP P34



INGREDIENT BOX P35



INGREDIENT BINS P36



INGREDIENT BINS P37



INGREDIENT BINS LIDP37



TRANSFER CONTAINER P38



K-LarderPro P39-P51



Preparation

SHELVING SERIES P53-P54



DOUGH BOXES P55-P57



SPINNER P58



CONDIMENT SET P59



PE CUTTING BOARD SER P60



Delivery

COVER P62



ROUND COVER P71



GN COVER AND BASE P63-P65



NON-SLIP TRAYS P72-P73



COVER P66-P67



FIBERGLASS TRAY P74-P76



BUFFET BARS P68-P70



PP TPAY P77



Enjoyment

BOWLS P79-P80



TUMBLERS P82-P83



BOWLS P80



PITCHERS P84



CONDIMENT SHAKER P81



MEASURING CUPS&COVERS P85



GRIP/SPOON/TURNER P82



Clean

UTILITY CARTS P87-P88



FULL SIZE CUP RACK P95-P97



BOXES P89



HALF FLAT WARE BASKET P98



TRASH CAN P90



TROLLEYS P99



FULL SIZE CUP RACK P91-P94





Storage



GN FOOD PANS



FOOD PAN LIDS



COLANDER PANS/DRAIN SHELF



STORAGE CONTAINER



CROCK/PUMP



INGREDIENT BINS/BOX



TRANSFER CONTAINER

GN FOOD PANS



Smooth inner surface is easy to clean



The label, which assists in a proper FIFO food storage system, is wipeable



The corner is textured, which can reduce scratching.

Allow the writing to dry thoroughly prior to refrigeration.



Erasable pen

CODE: GA0001
 COLOR: WHITE\BLACK\RED
 CASE PACK: 3PCS/SET
 sold separately



The label is wipeable and repetition

FOOD PANS(PC)

(US Standard)

Note: All graduations are approximate.

Material options for this series: Tritan / PPSU

2.5IN/65mm

4IN/100mm

6IN/150mm

8IN/200mm

GN1/1



| | | | | |
|-------------|-----------------|------------------|------------------|------------------|
| CODE: | GNU112-PC | GNU114-PC | GNU116-PC | GNU118-PC |
| DIMENSIONS: | L529xW324xH65mm | L529xW324xH100mm | L529xW324xH150mm | L529xW324xH200mm |
| CAPACITY: | 8.73L | 13.36L | 19.79L | 26.02L |
| CASE PACK: | 12pcs | 12pcs | 6pcs | 6pcs |

GN1/2

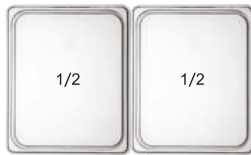

| | | | | |
|-------------|-----------------|------------------|------------------|------------------|
| CODE: | GNU212-PC | GNU214-PC | GNU216-PC | GNU218-PC |
| DIMENSIONS: | 4.01L | 6.1L | 9L | 11.7L |
| CAPACITY: | L324xW264xH65mm | L324xW264xH100mm | L324xW264xH150mm | L324xW264xH200mm |
| CASE PACK: | 24pcs | 24pcs | 12pcs | 12pcs |

GN1/3



| | | | | |
|-------------|-----------------|------------------|------------------|------------------|
| CODE: | GNU312-PC | GNU314-PC | GNU316-PC | GNU318-PC |
| DIMENSIONS: | L324xW175xH65mm | L324xW175xH100mm | L324xW175xH150mm | L324xW175xH200mm |
| CAPACITY: | 2.42L | 3.65L | 5.34L | 6.93L |
| CASE PACK: | 36pcs | 36pcs | 18pcs | 18pcs |

GN1/4



| | | | |
|-------------|-----------------|------------------|------------------|
| CODE: | GNU412-PC | GNU414-PC | GNU416-PC |
| DIMENSIONS: | L264xW161xH65mm | L264xW161xH100mm | L264xW161xH150mm |
| CAPACITY: | 1.73L | 2.59L | 3.76L |
| CASE PACK: | 48pcs | 48pcs | 36pcs |

GN1/6



| | | | | |
|-------------|-----------------|------------------|------------------|------------------|
| CODE: | GNU612-PC | GNU614-PC | GNU616-PC | GNU618-PC |
| DIMENSIONS: | L175xW161xH65mm | L175xW161xH100mm | L175xW161xH150mm | L175xW161xH200mm |
| CAPACITY: | 1.03L | 1.54L | 2.23L | 2.84L |
| CASE PACK: | 72pcs | 72pcs | 54pcs | 36pcs |

GN1/9



| | | | |
|-------------|-----------------|------------------|------------------|
| CODE: | GNU912-PC | GNU914-PC | GNU916-PC |
| DIMENSIONS: | L175xW108xH65mm | L175xW108xH100mm | L175xW108xH150mm |
| CAPACITY: | 584ml | 867ml | 1.24L |
| CASE PACK: | 72pcs | 108pcs | 72pcs |

FOOD PANS(PP)

(US Standard)

Note:All graduations are approximate.

2.5IN/65mm

4IN/100mm

6IN/150mm

8IN/200mm

GN1/1



| | | | | |
|-------------|-----------------|------------------|------------------|------------------|
| CODE: | GNU112-PP | GNU114-PP | GNU116-PP | GNU118-PP |
| DIMENSIONS: | L528xW324xH65mm | L528xW324xH100mm | L528xW324xH150mm | L528xW324xH200mm |
| CAPACITY: | 8.73L | 13.36L | 19.79L | 26.02L |
| CASE PACK: | 12pcs | 12pcs | 6pcs | 6pcs |

GN1/2



| | | | | |
|-------------|-----------------|------------------|------------------|------------------|
| CODE: | GNU212-PP | GNU214-PP | GNU216-PP | GNU218-PP |
| DIMENSIONS: | L323xW264xH65mm | L323xW264xH100mm | L323xW264xH150mm | L323xW264xH200mm |
| CAPACITY: | 4.01L | 6.1L | 9L | 11.7L |
| CASE PACK: | 24pcs | 24pcs | 12pcs | 12pcs |

GN1/3



| | | | | |
|-------------|-----------------|------------------|------------------|------------------|
| CODE: | GNU312-PP | GNU314-PP | GNU316-PP | GNU318-PP |
| DIMENSIONS: | L323xW175xH65mm | L323xW175xH100mm | L323xW175xH150mm | L323xW175xH200mm |
| CAPACITY: | 2.42L | 3.65L | 5.34L | 6.93L |
| CASE PACK: | 36pcs | 36pcs | 18pcs | 18pcs |

GN1/4



| | | | |
|-------------|-----------------|------------------|------------------|
| CODE: | GNU412-PP | GNU414-PP | GNU416-PP |
| DIMENSIONS: | L264xW161xH65mm | L264xW161xH100mm | L264xW161xH150mm |
| CAPACITY: | 1.73L | 2.59L | 3.76L |
| CASE PACK: | 72pcs | 48pcs | 36pcs |

GN1/6



| | | | | |
|-------------|-----------------|------------------|------------------|------------------|
| CODE: | GNU612-PP | GNU614-PP | GNU616-PP | GNU618-PP |
| DIMENSIONS: | L175xW161xH65mm | L175xW161xH100mm | L175xW161xH150mm | L175xW161xH200mm |
| CAPACITY: | 1.03L | 1.54L | 2.23L | 2.84L |
| CASE PACK: | 72pcs | 72pcs | 54pcs | 54pcs |

GN1/9



| | | | |
|-------------|-----------------|------------------|------------------|
| CODE: | GNU912-PP | GNU914-PP | GNU916-PP |
| DIMENSIONS: | L175xW108xH65mm | L175xW108xH100mm | L175xW108xH150mm |
| CAPACITY: | 584ml | 867ml | 1.24L |
| CASE PACK: | 72pcs | 72pcs | 72pcs |

LID (PP)

(US Standard)



AIRTIGHT LID (PP)



FLAT COVER (PP)



SEAL COVER (PP)

GN1/1



| | | | |
|-------------|-----------------|-----------------|-----------------|
| CODE: | GNU11-1PP | GNU11-2PP | GNU11-7PP |
| DIMENSIONS: | L538xW324xH22mm | L533xW328xH11mm | L529xW323xH19mm |
| CASE PACK: | 24pcs | 36pcs | 30pcs |

GN1/2



| | | | |
|-------------|-----------------|-----------------|-----------------|
| CODE: | GNU21-1PP | GNU21-2PP | GNU21-7PP |
| DIMENSIONS: | L323xW264xH22mm | L328xW269xH11mm | L322xW265xH19mm |
| CASE PACK: | 36pcs | 72pcs | 48pcs |

GN1/3



| | | | |
|-------------|-----------------|-----------------|-----------------|
| CODE: | GNU31-1PP | GNU31-2PP | GNU31-7PP |
| DIMENSIONS: | L323xW174xH22mm | L328xW180xH11mm | L322xW175xH19mm |
| CASE PACK: | 36pcs | 72pcs | 72pcs |

GN1/4



| | | | |
|-------------|-----------------|-----------------|-----------------|
| CODE: | GNU41-1PP | GNU41-2PP | GNU41-7PP |
| DIMENSIONS: | L263xW160xH22mm | L269xW166xH11mm | L260xW160xH19mm |
| CASE PACK: | 36pcs | 72pcs | 72pcs |

GN1/6



| | | | |
|-------------|-----------------|-----------------|-----------------|
| CODE: | GNU61-1PP | GNU61-2PP | GNU61-7PP |
| DIMENSIONS: | L174xW159xH22mm | L180xW166xH11mm | L175xW160xH19mm |
| CASE PACK: | 72pcs | 72pcs | 72pcs |

GN1/9



| | | | |
|-------------|-----------------|-----------------|-----------------|
| CODE: | GNU91-1PP | GNU91-2PP | GNU91-7PP |
| DIMENSIONS: | L175xW108xH22mm | L180xW113xH11mm | L175xW108xH19mm |
| CASE PACK: | 72pcs | 72pcs | 72pcs |



LID (PC) (US Standard)

Material options for this series: Tritan / PPSU



COVER WITH HANDLE (PC)



NOTCHED COVER WITH HANDLE (PC)



FLIP LID (PC)



NOTCHED FLIP LID (PC)

GN1/1



| | | |
|-------------|-----------------|-----------------|
| CODE: | GNU11-3PC | GNU11-4PC |
| DIMENSIONS: | L527xW323xH26mm | L527xW323xH31mm |
| CASE PACK: | 18pcs | 18pcs |

GN1/2



| | | | | |
|-------------|-----------------|-----------------|---------------------|---------------------|
| CODE: | GNU21-3PC | GNU21-4PC | GNU21-5PC | GNU21-11PC |
| DIMENSIONS: | L323xW263xH27mm | L323xW263xH32mm | L323.5xW264xH19.9mm | L323.5xW264xH19.9mm |
| CASE PACK: | 48pcs | 48pcs | 48pcs | 48pcs |

GN1/3



| | | | | |
|-------------|-----------------|-----------------|---------------------|---------------------|
| CODE: | GNU31-3PC | GNU31-4PC | GNU31-5PC | GNU31-11PC |
| DIMENSIONS: | L322xW174xH23mm | L322xW174xH27mm | L323.5xW175xH19.9mm | L323.5xW175xH19.9mm |
| CASE PACK: | 72pcs | 72pcs | 48pcs | 48pcs |

GN1/4



| | | | | |
|-------------|-----------------|-----------------|-------------------|-------------------|
| CODE: | GNU41-3PC | GNU41-4PC | GNU41-5PC | GNU41-11PC |
| DIMENSIONS: | L263xW160xH25mm | L263xW160xH27mm | L264xW161xH19.9mm | L264xW161xH19.9mm |
| CASE PACK: | 72pcs | 72pcs | 72pcs | 72pcs |

GN1/6



| | | | | |
|-------------|-----------------|-----------------|-------------------|-------------------|
| CODE: | GNU61-3PC | GNU61-4PC | GNU61-5PC | GNU61-11PC |
| DIMENSIONS: | L174xW160xH23mm | L174xW160xH28mm | L175xW161xH19.9mm | L175xW161xH19.9mm |
| CASE PACK: | 72pcs | 72pcs | 72pcs | 72pcs |

GN1/9



| | | | | |
|-------------|-----------------|-----------------|-------------------|-------------------|
| CODE: | GNU91-3PC | GNU91-4PC | GNU91-5PC | GNU91-11PC |
| DIMENSIONS: | L174xW107xH10mm | L174xW107xH14mm | L175xW108xH19.9mm | L175xW108xH19.9mm |
| CASE PACK: | 72pcs | 72pcs | 72pcs | 72pcs |

1/1 SLID LID

(US Standard)

Material options for this series: Tritan / PPSU



CODE: GNU11-14PC
 DIMENSIONS: L528.5xW323.5xH40.3mm
 CASE PACK: 18pcs

GN COLANDER PANS



Rinse, drain and store—all in one pan
 Both covers with handles and notched covers with handles fit on pans with colanders.

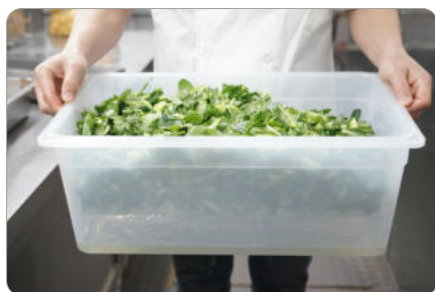

Ideal for prepped produce, poultry, storing meats, defrosting, and storing seafood on ice



Liquids drain easily into the food pan below, enhancing food quality and reducing handling.

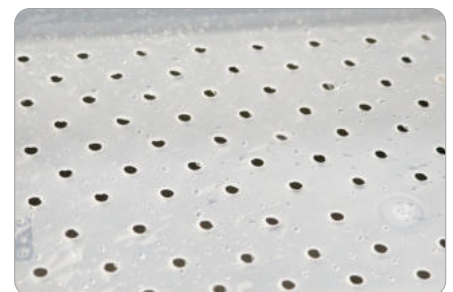

Drain hole dimension: 6.5mm

COLANDER PANS (PC)

Material options for this series: Tritan / PPSU
(US Standard)

Minimum Filter Capacity

GN1/1



| | | | |
|-------------|-----------------|------------------|------------------|
| CODE: | GNU114-PCW | GNU116-PCW | GNU118-PCW |
| DIMENSIONS: | L527xW324xH84mm | L527xW324xH134mm | L527xW324xH184mm |
| CASE PACK: | 12pcs | 12pcs | 6pcs |



2L

GN1/2



| | | | |
|-------------|-----------------|------------------|------------------|
| CODE: | GNU214-PCW | GNU216-PCW | GNU218-PCW |
| DIMENSIONS: | L322xW262xH84mm | L322xW262xH134mm | L322xW262xH184mm |
| CASE PACK: | 24pcs | 24pcs | 24pcs |



1L

GN1/3



| | | | |
|-------------|-----------------|------------------|------------------|
| CODE: | GNU314-PCW | GNU316-PCW | GNU318-PCW |
| DIMENSIONS: | L323xW175xH84mm | L323xW175xH134mm | L323xW175xH184mm |
| CASE PACK: | 48pcs | 36pcs | 24pcs |



0.6L

GN1/4



| | | |
|-------------|-----------------|------------------|
| CODE: | GNU414-PCW | GNU416-PCW |
| DIMENSIONS: | L264xW161xH84mm | L264xW161xH134mm |
| CASE PACK: | 48pcs | 48pcs |



0.45L

GN1/6



| | | | |
|-------------|-----------------|------------------|------------------|
| CODE: | GNU614-PCW | GNU616-PCW | GNU618-PCW |
| DIMENSIONS: | L173xW160xH84mm | L173xW160xH134mm | L173xW160xH184mm |
| CASE PACK: | 72pcs | 72pcs | 36pcs |



0.2L

COLANDER PANS (PP)

(US Standard)

| | | | Minimum Filter Capacity |
|--------------|-----------------|------------------|-------------------------|
| | | | |
| GN1/1 | | | |
| CODE: | GNU114-PPW | GNU116-PPW | GNU118-PPW |
| DIMENSIONS: | L527xW324xH84mm | L527xW324xH134mm | L527xW324xH184mm |
| CASE PACK: | 12pcs | 12pcs | 6pcs |
| | | | 2L |
| | | | |
| GN1/2 | | | |
| CODE: | GNU214-PPW | GNU216-PPW | GNU218-PPW |
| DIMENSIONS: | L322xW262xH84mm | L322xW262xH134mm | L322xW262xH184mm |
| CASE PACK: | 24pcs | 24pcs | 24pcs |
| | | | 1L |
| | | | |
| GN1/3 | | | |
| CODE: | GNU314-PPW | GNU316-PPW | GNU318-PPW |
| DIMENSIONS: | L323xW175xH84mm | L323xW175xH134mm | L323xW175xH184mm |
| CASE PACK: | 48pcs | 48pcs | 36pcs |
| | | | 0.6L |
| | | | |
| GN1/4 | | | |
| CODE: | GNU414-PPW | GNU416-PPW | |
| DIMENSIONS: | L264xW161xH84mm | L264xW161xH134mm | |
| CASE PACK: | 48pcs | 48pcs | |
| | | | 0.45L |
| | | | |
| GN1/6 | | | |
| CODE: | GNU614-PPW | GNU616-PPW | GNU618-PPW |
| DIMENSIONS: | L173xW160xH84mm | L173xW160xH134mm | L173xW160xH184mm |
| CASE PACK: | 72pcs | 72pcs | 36pcs |
| | | | 0.2L |

DRAIN SHELF

(US Standard)

Fits all food pan sizes, Fast drainage, keeps ingredients dry



- Available for all food pan sizes.
- The 12.6mm depth separates food and liquid, which helps preserve food quality.

DRAIN SHELF (PC)

Material options for this series: Tritan / PPSU



CODE: GNU11-PCD
 DIMENSIONS: L458xW256xH15mm
 CASE PACK: 36pcs



CODE: GNU21-PCD
 DIMENSIONS: L256xW196xH15mm
 CASE PACK: 72pcs



CODE: GNU31-PCD
 DIMENSIONS: L258xW110xH15mm
 CASE PACK: 72pcs



CODE: GNU41-PCD
 DIMENSIONS: L205xW103xH15mm
 CASE PACK: 72pcs



CODE: GNU61-PCD
 DIMENSIONS: L110xW97xH15mm
 CASE PACK: 72pcs



CODE: GNU91-PCD
 DIMENSIONS: L118xW53xH15mm
 CASE PACK: 72pcs

DRAIN SHELF (PP)



CODE: GNU11-PPD
 DIMENSIONS: L458xW256xH15mm
 CASE PACK: 36pcs



CODE: GNU21-PPD
 DIMENSIONS: L256xW196xH15mm
 CASE PACK: 72pcs



CODE: GNU31-PPD
 DIMENSIONS: L258xW110xH15mm
 CASE PACK: 72pcs



CODE: GNU41-PPD
 DIMENSIONS: L205xW103xH15mm
 CASE PACK: 72pcs



CODE: GNU61-PPD
 DIMENSIONS: L110xW97xH15mm
 CASE PACK: 72pcs



CODE: GNU91-PPD
 DIMENSIONS: L118xW53xH15mm
 CASE PACK: 72pcs

FOOD PANS (Tritan)

(EU Standard)

Note: All graduations are approximate.
Material options for this series: PPSU

2.5IN/65mm

4IN/100mm

6IN/150mm

8IN/200mm

GN1/1



| | | | | |
|-------------|---------------------|----------------------|----------------------|----------------------|
| CODE: | GNE112-T | GNE114-T | GNE116-T | GNE118-T |
| DIMENSIONS: | L528.5xW323.5xH65mm | L528.5xW323.5xH100mm | L528.5xW323.5xH150mm | L528.5xW323.5xH200mm |
| CAPACITY: | 8.88L | 13.58L | 20.13L | 26.47L |
| CASE PACK: | 6pcs | 6pcs | 6pcs | 6pcs |

GN1/2

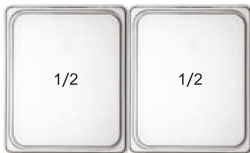

| | | | | |
|-------------|-------------------|--------------------|--------------------|--------------------|
| CODE: | GNE212-T | GNE214-T | GNE216-T | GNE218-T |
| DIMENSIONS: | L323.5xW264xH65mm | L323.5xW264xH100mm | L323.5xW264xH150mm | L323.5xW264xH200mm |
| CAPACITY: | 4.06L | 6.18L | 9.13L | 11.88L |
| CASE PACK: | 6pcs | 6pcs | 6pcs | 6pcs |

GN1/3



| | | | | |
|-------------|-----------------|------------------|------------------|------------------|
| CODE: | GNE312-T | GNE314-T | GNE316-T | GNE318-T |
| DIMENSIONS: | L323xW175xH65mm | L323xW175xH100mm | L323xW175xH150mm | L323xW175xH200mm |
| CAPACITY: | 2.5L | 3.77L | 5.52L | 7.19L |
| CASE PACK: | 36pcs | 36pcs | 18pcs | 18pcs |

GN1/4



| | | | |
|-------------|-----------------|------------------|------------------|
| CODE: | GNE412-T | GNE414-T | GNE416-T |
| DIMENSIONS: | L264xW161xH65mm | L264xW161xH100mm | L264xW161xH150mm |
| CAPACITY: | 1.77L | 2.59L | 3.87L |
| CASE PACK: | 48pcs | 48pcs | 36pcs |

GN1/6



| | | | | |
|-------------|-----------------|------------------|------------------|------------------|
| CODE: | GNE612-T | GNE614-T | GNE616-T | GNE618-T |
| DIMENSIONS: | L175xW161xH65mm | L175xW161xH100mm | L175xW161xH150mm | L175xW161xH200mm |
| CAPACITY: | 1.3L | 1.62L | 2.36L | 3.01L |
| CASE PACK: | 72pcs | 72pcs | 54pcs | 36pcs |

GN1/9



| | | | |
|-------------|-----------------|------------------|------------------|
| CODE: | GNE912-T | GNE914-T | GNE916-T |
| DIMENSIONS: | L175xW108xH65mm | L175xW108xH100mm | L175xW108xH150mm |
| CAPACITY: | 625ml | 927ml | 1.34L |
| CASE PACK: | 72pcs | 72pcs | 72pcs |



FOOD PANS (PP)

(EU Standard)

Note: All graduations are approximate.

2.5IN/65mm

4IN/100mm

6IN/150mm

8IN/200mm

GN1/1



| | | | | |
|-------------|-----------------|------------------|------------------|------------------|
| CODE: | GNE112-PP | GNE114-PP | GNE116-PP | GNE118-PP |
| DIMENSIONS: | L526xW322xH65mm | L526xW322xH100mm | L526xW322xH150mm | L526xW322xH200mm |
| CAPACITY: | 8.88L | 13.58L | 20.13L | 26.47L |
| CASE PACK: | 12pcs | 12pcs | 6pcs | 6pcs |

GN1/2

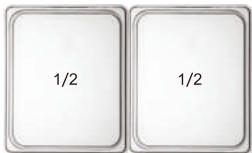

| | | | | |
|-------------|-----------------|------------------|------------------|------------------|
| CODE: | GNE212-PP | GNE214-PP | GNE216-PP | GNE218-PP |
| DIMENSIONS: | L323xW263xH65mm | L323xW263xH100mm | L323xW263xH150mm | L323xW263xH200mm |
| CAPACITY: | 4.06L | 6.18L | 9.13L | 11.88L |
| CASE PACK: | 24pcs | 24pcs | 12pcs | 12pcs |

GN1/3



| | | | | |
|-------------|-----------------|------------------|------------------|------------------|
| CODE: | GNE312-PP | GNE314-PP | GNE316-PP | GNE318-PP |
| DIMENSIONS: | L323xW175xH65mm | L323xW175xH100mm | L323xW175xH150mm | L323xW175xH200mm |
| CAPACITY: | 2.5L | 3.77L | 5.52L | 7.19L |
| CASE PACK: | 36pcs | 36pcs | 18pcs | 18pcs |

GN1/4



| | | | |
|-------------|-----------------|------------------|------------------|
| CODE: | GNE412-PP | GNE414-PP | GNE416-PP |
| DIMENSIONS: | L263xW160xH65mm | L263xW160xH100mm | L263xW160xH150mm |
| CAPACITY: | 1.77L | 2.59L | 3.87L |
| CASE PACK: | 72pcs | 48pcs | 36pcs |

GN1/6



| | | | | |
|-------------|-----------------|------------------|------------------|------------------|
| CODE: | GNE612-PP | GNE614-PP | GNE616-PP | GNE618-PP |
| DIMENSIONS: | L174xW160xH65mm | L174xW160xH100mm | L174xW160xH150mm | L174xW160xH200mm |
| CAPACITY: | 1.3L | 1.62L | 2.36L | 3.01L |
| CASE PACK: | 72pcs | 72pcs | 54pcs | 54pcs |

GN1/9



| | | | |
|-------------|-----------------|------------------|------------------|
| CODE: | GNE912-PP | GNE914-PP | GNE916-PP |
| DIMENSIONS: | L175xW108xH65mm | L175xW108xH100mm | L175xW108xH150mm |
| CAPACITY: | 625ml | 927ml | 1.34L |
| CASE PACK: | 72pcs | 72pcs | 72pcs |



LID (PP) (EU Standard)



AIRTIGHT LID (PP)



FLAT COVER (PP)



SEAL COVER (PP)

GN1/1



| | | | |
|-------------|-----------------|-----------------|-----------------|
| CODE: | GNE11-1PP | GNE11-2PP | GNE11-7PP |
| DIMENSIONS: | L526xW323xH22mm | L533xW328xH13mm | L530xW323xH19mm |
| CASE PACK: | 24pcs | 36pcs | 30pcs |

GN1/2



| | | | |
|-------------|-----------------|-----------------|-----------------|
| CODE: | GNE21-1PP | GNE21-2PP | GNE21-7PP |
| DIMENSIONS: | L323xW264xH22mm | L328xW269xH13mm | L323xW263xH19mm |
| CASE PACK: | 36pcs | 72pcs | 48pcs |

GN1/3



| | | | |
|-------------|-----------------|-----------------|-----------------|
| CODE: | GNE31-1PP | GNE31-2PP | GNE31-7PP |
| DIMENSIONS: | L323xW174xH22mm | L328xW180xH13mm | L322xW175xH19mm |
| CASE PACK: | 54pcs | 72pcs | 72pcs |

GN1/4



| | | | |
|-------------|-----------------|-----------------|-----------------|
| CODE: | GNE41-1PP | GNE41-2PP | GNE41-7PP |
| DIMENSIONS: | L263xW160xH22mm | L269xW166xH13mm | L263xW161xH19mm |
| CASE PACK: | 72pcs | 72pcs | 72pcs |

GN1/6



| | | | |
|-------------|-----------------|-----------------|-----------------|
| CODE: | GNE61-1PP | GNE61-2PP | GNE61-7PP |
| DIMENSIONS: | L174xW160xH22mm | L180xW166xH13mm | L175xW161xH19mm |
| CASE PACK: | 72pcs | 72pcs | 72pcs |

GN1/9



| | | | |
|-------------|-----------------|-----------------|-----------------|
| CODE: | GNE91-1PP | GNE91-2PP | GNE91-7PP |
| DIMENSIONS: | L174xW107xH22mm | L180xW113xH13mm | L176xW109xH19mm |
| CASE PACK: | 72pcs | 72pcs | 72pcs |



LID (Tritan)

(EU Standard)

Material options for this series: PPSU



COVER WITH HANDLE (Tritan)



NOTCHED COVER WITH HANDLE (Tritan)



FLIP LID (Tritan)



NOTCHED FLIP LID (Tritan)

GN1/1



| | | |
|-------------|-----------------|-----------------|
| CODE: | GNE11-3T | GNE11-4T |
| DIMENSIONS: | L527xW323xH27mm | L527xW323xH31mm |
| CASE PACK: | 18pcs | 18pcs |

GN1/2



| | | | | |
|-------------|-----------------|-----------------|-------------------|-------------------|
| CODE: | GNE21-3T | GNE21-4T | GNE21-5T | GNE21-11T |
| DIMENSIONS: | L323xW263xH30mm | L323xW263xH32mm | L323xW263.5xH16mm | L323xW263.5xH16mm |
| CASE PACK: | 48pcs | 48pcs | 48pcs | 48pcs |

GN1/3



| | | | | |
|-------------|-----------------|-----------------|-------------------|-------------------|
| CODE: | GNE31-3T | GNE31-4T | GNE31-5T | GNE31-11T |
| DIMENSIONS: | L322xW174xH28mm | L322xW174xH28mm | L323.5xW175xH15mm | L323.5xW175xH15mm |
| CASE PACK: | 72pcs | 72pcs | 48pcs | 48pcs |

GN1/4



| | | | | |
|-------------|-----------------|-----------------|-----------------|-----------------|
| CODE: | GNE41-3T | GNE41-4T | GNE41-5T | GNE41-11T |
| DIMENSIONS: | L263xW160xH25mm | L263xW160xH27mm | L263xW160xH18mm | L263xW160xH18mm |
| CASE PACK: | 72pcs | 72pcs | 72pcs | 72pcs |

GN1/6



| | | | | |
|-------------|-----------------|-----------------|-----------------|-----------------|
| CODE: | GNE61-3T | GNE61-4T | GNE61-5T | GNE61-11T |
| DIMENSIONS: | L174xW160xH23mm | L174xW160xH28mm | L175xW161xH16mm | L175xW161xH16mm |
| CASE PACK: | 72pcs | 72pcs | 72pcs | 72pcs |

GN1/9



| | | | | |
|-------------|-----------------|-----------------|-----------------|-----------------|
| CODE: | GNE91-3T | GNE91-4T | GNE91-5T | GNE91-11T |
| DIMENSIONS: | L174xW107xH10mm | L174xW107xH14mm | L173xW108xH15mm | L173xW108xH15mm |
| CASE PACK: | 72pcs | 72pcs | 72pcs | 72pcs |



FOOD PANS (Tritan)

(EU Standard)

Note: All graduations are approximate.
Material options for this series: PPSU

GN2/4



| | | | | |
|-------------|-----------------|------------------|-----------------|-----------------|
| CODE: | GNE422-T | GNE424-T | GNE42-3T | GNE42-4T |
| DIMENSIONS: | L528xW160xH65mm | L528xW160xH100mm | L526xW160xH25mm | L526xW160xH25mm |
| CAPACITY: | 3.92L | 5.92L | \ | \ |
| CASE PACK: | 24pcs | 24pcs | 48pcs | 48pcs |

GN2/1



| | | | | |
|-------------|--------------------|--------------------|-----------------------|-----------------------|
| CODE: | GNE126-T | GNE128-T | GNE12-8T | GNE11-14T |
| DIMENSIONS: | L648xW529.5xH150mm | L648xW529.5xH200mm | L649.5xW528.5xH23.5mm | L536.5xW330.5xH42.1mm |
| CAPACITY: | 40L | 53.8L | \ | \ |
| CASE PACK: | 6pcs | 6pcs | 6pcs | 12pcs |

1/1 SLID LID
(EU Standard)

FOOD PANS (PP)

(EU Standard)

Note: All graduations are approximate.



GN2/3



| | | | | |
|-------------|-----------------|------------------|------------------|------------------|
| CODE: | GNE322-PP | GNE324-PP | GNE326-PP | GNE328-PP |
| DIMENSIONS: | L352xW322xH65mm | L352xW322xH100mm | L352xW322xH150mm | L352xW322xH200mm |
| CAPACITY: | 5.72L | 8.75L | 13L | 17.09L |
| CASE PACK: | 12pcs | 12pcs | 6pcs | 6pcs |



| | |
|-------------|-----------------|
| CODE: | GNE32-1PP |
| DIMENSIONS: | L352xW323xH22mm |
| CASE PACK: | 24pcs |

COLANDER PANS (Tritan)

Material options for this series: PPSU
(EU Standard)

Minimum Filter Capacity

GN1/1



| | | | |
|-------------|-----------------|------------------|------------------|
| CODE: | GNE114-TW | GNE116-TW | GNE118-TW |
| DIMENSIONS: | L527xW324xH84mm | L527xW324xH134mm | L527xW324xH184mm |
| CASE PACK: | 6pcs | 6pcs | 6pcs |



2L

GN1/2



| | | | |
|-------------|-----------------|------------------|------------------|
| CODE: | GNE214-TW | GNE216-TW | GNE218-TW |
| DIMENSIONS: | L322xW262xH84mm | L322xW262xH134mm | L322xW262xH184mm |
| CASE PACK: | 6pcs | 6pcs | 6pcs |



1L

GN1/3



| | | | |
|-------------|-----------------|------------------|------------------|
| CODE: | GNE314-TW | GNE316-TW | GNE318-TW |
| DIMENSIONS: | L323xW175xH84mm | L323xW175xH134mm | L323xW175xH184mm |
| CASE PACK: | 36pcs | 18pcs | 18pcs |



0.6L

GN1/4



| | | |
|-------------|-----------------|------------------|
| CODE: | GNE414-TW | GNE416-TW |
| DIMENSIONS: | L264xW161xH84mm | L264xW161xH133mm |
| CASE PACK: | 48pcs | 36pcs |



0.45L

GN1/6



| | | | |
|-------------|-----------------|------------------|------------------|
| CODE: | GNE614-TW | GNE616-TW | GNE618-TW |
| DIMENSIONS: | L173xW160xH84mm | L173xW160xH134mm | L173xW160xH184mm |
| CASE PACK: | 72pcs | 54pcs | 36pcs |



0.2L

COLANDER PANS (PP)

(EU Standard)

GN1/1

| | | | |
|-------------|-----------------|------------------|------------------|
| CODE: | GNE114-PPW | GNE116-PPW | GNE118-PPW |
| DIMENSIONS: | L527xW324xH84mm | L527xW324xH134mm | L527xW324xH184mm |
| CASE PACK: | 12pcs | 12pcs | 6pcs |

Minimum Filter Capacity



2L

GN1/2

| | | | |
|-------------|-----------------|------------------|------------------|
| CODE: | GNE214-PPW | GNE216-PPW | GNE218-PPW |
| DIMENSIONS: | L322xW262xH84mm | L322xW262xH134mm | L322xW262xH184mm |
| CASE PACK: | 24pcs | 24pcs | 24pcs |



1L

GN1/3

| | | | |
|-------------|-----------------|------------------|------------------|
| CODE: | GNE314-PPW | GNE316-PPW | GNE318-PPW |
| DIMENSIONS: | L323xW175xH84mm | L323xW175xH134mm | L323xW175xH184mm |
| CASE PACK: | 48pcs | 48pcs | 36pcs |



0.6L

GN1/4

| | | |
|-------------|-----------------|------------------|
| CODE: | GNE414-PPW | GNE416-PPW |
| DIMENSIONS: | L264xW161xH84mm | L264xW161xH134mm |
| CASE PACK: | 48pcs | 48pcs |



0.45L

GN1/6

| | | | |
|-------------|-----------------|------------------|------------------|
| CODE: | GNE614-PPW | GNE616-PPW | GNE618-PPW |
| DIMENSIONS: | L173xW160xH84mm | L173xW160xH134mm | L173xW160xH184mm |
| CASE PACK: | 72pcs | 72pcs | 36pcs |



0.2L

DRAIN SHELF

(EU Standard)

Fits all food pan sizes, Fast drainage, keeps ingredients dry



- Available for all food pan sizes.
- The 12.6mm depth separates food and liquid, which helps preserve food quality.

DRAIN SHELF (Tritan)

Material options for this series: PPSU



| | | | | |
|-------------|-----------------|-----------------|-----------------|-----------------|
| CODE: | GNE42-TD | GNE32-TD | GNE11-TD | GNE21-TD |
| DIMENSIONS: | L480xW114xH15mm | L293xW263xH15mm | L464xW260xH15mm | L260xW200xH15mm |
| CASE PACK: | 72pcs | 36pcs | 36pcs | 72pcs |



| | | | | |
|-------------|-----------------|-----------------|-----------------|----------------|
| CODE: | GNE31-TD | GNE41-TD | GNE61-TD | GNE91-TD |
| DIMENSIONS: | L263xW116xH15mm | L210xW108xH15mm | L118xW104xH15mm | L125xW60xH15mm |
| CASE PACK: | 72pcs | 72pcs | 72pcs | 72pcs |

DRAIN SHELF (PP)



| | | | | |
|-------------|-----------------|-----------------|-----------------|-----------------|
| CODE: | GNE42-PPD | GNE32-PPD | GNE11-PPD | GNE21-PPD |
| DIMENSIONS: | L480xW114xH15mm | L293xW263xH15mm | L464xW260xH15mm | L260xW200xH15mm |
| CASE PACK: | 72pcs | 36pcs | 36pcs | 72pcs |



| | | | | |
|-------------|-----------------|-----------------|-----------------|----------------|
| CODE: | GNE31-PPD | GNE41-PPD | GNE61-PPD | GNE91-PPD |
| DIMENSIONS: | L263xW116xH15mm | L210xW108xH15mm | L118xW104xH15mm | L125xW60xH15mm |
| CASE PACK: | 72pcs | 72pcs | 72pcs | 72pcs |

HIGH HEAT FOOD PANS

The PPSU high-temperature food pan with handles is a professional kitchen utensil designed for efficient operation of fast-food chains. Its key advantages lie in high heat-resistance, impact-resistance, ease of operation, and compliance with safety regulations.



Superior heat resistance + hydrolysis resistance: capable of withstanding temperatures ranging from -40 to 190°C. Compatible with all leading manufacturers' commercial kitchens teamers and insulated containers (including single-sided mode and penetration mode) with dishwashers; no deformation or cracking.

Safety and compliance + no residues: Food-grade PPSU with no BPA, certified by organizations such as NSF/FDA, resistant to acids, bases, and oils. It does not harbor dirt or grime, meeting the hygiene standards of fast-food chains.

With a handle + easy to operate: Unibody, heat-resistant handle design ensures that it remains cool to the touch even when handled at high temperatures, reducing the risk of slipping and making it suitable for high-volume food service. Faster turn around times to reduce operational risks.

Transparent visibility + controllable costs: The transparent basin body makes it easy to quickly check the remaining quantity of ingredients, reducing the need to open the lid frequently. It is lighter than stainless steel. It is highly resistant to wear and tear over the long-term, resulting in lower overall operating costs.



CODE: GNU312-HPA
 DIMENSIONS: L423xW172xH65mm
 CAPACITY: 2.1L
 CASE PACK: 24pcs

GNU312-HPC
 L525xW172xH65mm
 2.1L
 24pcs

GNU112-HPB
 L635*W325*H65mm
 8.73L
 12pcs



All food pans, colanders, drain shelves and lids can be manufactured from PPSU.

S/S FOOD PANS



- Pans are made of stainless steel 304#,standard size
- Rounded edges reduce the risk of cuts or injuries



Safe, smooth edges for easy movement.



Safe for steamer & oven use



Refrigerator & freezer safe



Round U-corner design is stackable



Silicone seal + locking lid: slosh-proof guaranteed

















The label is wipeable and repetition

FOOD PAN CAPACITY GUIDE



S/S FOOD PANS (STAINLESS STEEL COVER)

| | 2.5IN/65mm | 4IN/100mm | 6IN/150mm | 8IN/200mm | |
|--------------|---|---|---|---|---|
| GN1/1 |  |  |  |  |  |
| CODE: | GN111-9SS | GN112-SSD | GN114-SSD | GN116-SSD | GN118-SSD |
| DIMENSIONS: | L530xW326xH27mm | L530xW326xH65mm | L530xW326xH100mm | L530xW326xH150mm | L530xW326xH200mm |
| CAPACITY: | \ | 8.5L | 13L | 20L | 26L |
| CASE PACK: | 6pcs | 6pcs | 6pcs | 6pcs | 6pcs |
| GN1/2 |  |  |  |  |  |
| CODE: | GN211-9SS | GN212-SSD | GN214-SSD | GN216-SSD | GN218-SSD |
| DIMENSIONS: | L325xW265xH25mm | L326xW267xH65mm | L326xW267xH100mm | L326xW267xH150mm | L326xW267xH200mm |
| CAPACITY: | \ | 4L | 6L | 8.7L | 11.5L |
| CASE PACK: | 18pcs | 12pcs | 12pcs | 6pcs | 6pcs |
| GN1/3 |  |  |  |  |  |
| CODE: | GN311-9SS | GN312-SSD | GN314-SSD | GN316-SSD | GN318-SSD |
| DIMENSIONS: | L325xW177xH27mm | L325xW176xH65mm | L325xW176xH100mm | L325xW176xH150mm | L325xW176xH200mm |
| CAPACITY: | \ | 2.5L | 3.9L | 5.5L | 7.3L |
| CASE PACK: | 24pcs | 12pcs | 12pcs | 12pcs | 6pcs |
| GN1/4 |  |  |  |  |  |
| CODE: | GN411-9SS | GN412-SSD | GN414-SSD | GN416-SSD | GN418-SSD |
| DIMENSIONS: | L265xW163xH27mm | L265xW162xH65mm | L265xW162xH100mm | L265xW162xH150mm | L265xW162xH200mm |
| CAPACITY: | \ | 1.8L | 2.7L | 3.8L | 5L |
| CASE PACK: | 36pcs | 18pcs | 12pcs | 12pcs | 12pcs |
| GN1/6 |  |  |  |  |  |
| CODE: | GN611-9SS | GN612-SSD | GN614-SSD | GN616-SSD | GN618-SSD |
| DIMENSIONS: | L177xW163xH27mm | L176xW163xH65mm | L176xW163xH100mm | L176xW163xH150mm | L176xW163xH200mm |
| CAPACITY: | \ | 1L | 1.6L | 2.3L | 3L |
| CASE PACK: | 48pcs | 24pcs | 24pcs | 12pcs | 12pcs |
| GN1/9 |  |  |  |  | |
| CODE: | GN911-9SS | GN912-SSD | GN914-SSD | GN916-SSD | |
| DIMENSIONS: | L177xW109xH27mm | L175xW108xH65mm | L175xW108xH100mm | L175xW108xH150mm | |
| CAPACITY: | \ | 0.6L | 0.9L | 1.3L | |
| CASE PACK: | 72pcs | 36pcs | 36pcs | 18pcs | |

S/S FOOD PANS (PC COVER)

2.5IN/65mm

4IN/100mm

6IN/150mm

8IN/200mm

GN1/1

| | | | | | |
|-------------|-----------------|-----------------|------------------|------------------|------------------|
| CODE: | GN11-10PC | GN112-SSE | GN114-SSE | GN116-SSE | GN118-SSE |
| DIMENSIONS: | L582xW383xH16mm | L527xW326xH65mm | L527xW326xH100mm | L527xW326xH150mm | L527xW326xH200mm |
| CAPACITY: | \ | 8.5L | 13L | 19.5L | 26L |
| CASE PACK: | 12pcs | 6pcs | 6pcs | 6pcs | 6pcs |

GN1/2

| | | | | | |
|-------------|-----------------|-----------------|------------------|------------------|------------------|
| CODE: | GN21-10PC | GN212-SSE | GN214-SSE | GN216-SSE | GN218-SSE |
| DIMENSIONS: | L375xW315xH16mm | L323xW261xH65mm | L323xW261xH100mm | L323xW261xH150mm | L323xW261xH200mm |
| CAPACITY: | \ | 3.9L | 6L | 8.8L | 11.8L |
| CASE PACK: | 36pcs | 12pcs | 12pcs | 6pcs | 6pcs |

GN1/3

| | | | | | |
|-------------|-----------------|-----------------|------------------|------------------|------------------|
| CODE: | GN31-10PC | GN312-SSE | GN314-SSE | GN316-SSE | GN318-SSE |
| DIMENSIONS: | L375xW225xH16mm | L326xW176xH65mm | L326xW176xH100mm | L326xW176xH150mm | L326xW176xH200mm |
| CAPACITY: | \ | 2.5L | 3.9L | 5.6L | 7.4L |
| CASE PACK: | 48pcs | 12pcs | 12pcs | 12pcs | 6pcs |

GN1/4

| | | | | | |
|-------------|-----------------|-----------------|------------------|------------------|------------------|
| CODE: | GN41-10PC | GN412-SSE | GN414-SSE | GN416-SSE | GN418-SSE |
| DIMENSIONS: | L375xW225xH16mm | L263xW158xH65mm | L263xW158xH100mm | L263xW158xH150mm | L263xW158xH200mm |
| CAPACITY: | \ | 1.7L | 2.6L | 3.8L | 4.9L |
| CASE PACK: | 48pcs | 18pcs | 12pcs | 12pcs | 12pcs |

GN1/6

| | | | | | |
|-------------|-----------------|-----------------|------------------|------------------|------------------|
| CODE: | GN61-10PC | GN612-SSE | GN614-SSE | GN616-SSE | GN618-SSE |
| DIMENSIONS: | L225xW210xH16mm | L174xW160xH65mm | L174xW160xH100mm | L174xW160xH150mm | L174xW160xH200mm |
| CAPACITY: | \ | 1.1L | 1.6L | 2.3L | 3L |
| CASE PACK: | 72pcs | 24pcs | 24pcs | 12pcs | 12pcs |

GN1/9

| | | | | |
|-------------|-----------------|-----------------|------------------|------------------|
| CODE: | GN91-10PC | GN912-SSE | GN914-SSE | GN916-SSE |
| DIMENSIONS: | L220xW153xH16mm | L169xW102xH65mm | L169xW102xH100mm | L169xW102xH150mm |
| CAPACITY: | \ | 0.6L | 0.9L | 1.3L |
| CASE PACK: | 108pcs | 36pcs | 36pcs | 18pcs |

FOOD PANS (PP) AND LIDS



Ideal for restaurant & kitchen use
Great for food storage, preparation & display
Perfect for table service & small items

1/1

4IN/100mm

6IN/150mm

8IN/200mm



| | | | |
|-------------|------------------|------------------|------------------|
| CODE: | HA01100 | HA01150 | HA01200 |
| DIMENSIONS: | L527xW322xH100mm | L527xW322xH150mm | L527xW322xH200mm |
| CAPACITY: | 12.5L | 18.9L | 25.0L |
| CASE PACK: | 12pcs | 14pcs | 12pcs |

| | | |
|-------------------|-----------------|-----------------|
| HA01A(PP) | HA01B(PP) | HA01C(PC) |
| L530xW325xH12.3mm | L530xW325xH13mm | L538xW335xH12mm |
| \ | \ | \ |
| 24pcs | 28pcs | 24pcs |

1/2



| | | | |
|-------------|----------------------|----------------------|----------------------|
| CODE: | HA02100 | HA02150 | HA02200 |
| DIMENSIONS: | L320.5xW260.5xH100mm | L321.5xW261.5xH150mm | L320.5xW260.5xH200mm |
| CAPACITY: | 5.5L | 8.0L | 10.5L |
| CASE PACK: | 24pcs | 28pcs | 24pcs |

| | | |
|------------------|-------------------|-----------------|
| HA02A(PP) | HA02B(PP) | HA02C(PC) |
| L322xW262xH9.6mm | L324xW264xH12.5mm | L331xW264xH12mm |
| \ | \ | \ |
| 48pcs | 48pcs | 60pcs |

1/3



| | | | |
|-------------|------------------|--------------------|------------------|
| CODE: | HA03100 | HA03150 | HA03200 |
| DIMENSIONS: | L321xW170xH100mm | L318.5xW170xH150mm | L321xW172xH200mm |
| CAPACITY: | 3.58L | 5.38L | 6.95L |
| CASE PACK: | 39pcs | 48pcs | 42pcs |

| | | |
|------------------|---------------------|-----------------|
| HA03A(PP) | HA03B(PP) | HA03C(PC) |
| L323xW174xH9.6mm | L324.6xW175.6xH15mm | L324xW175xH12mm |
| \ | \ | \ |
| 72pcs | 72pcs | 72pcs |

1/4



| | | |
|-------------|----------------------|----------------------|
| CODE: | HA 04100 | HA 04150 |
| DIMENSIONS: | L261.5xW158.5xH100mm | L261.5xW158.5xH150mm |
| CAPACITY: | 2.5L | 3.8L |
| CASE PACK: | 56pcs | 64pcs |

| | |
|------------------|-------------------|
| HA04A(PP) | HA04B(PC) |
| L263xW160xH9.6mm | L265xW162.1xH15mm |
| \ | \ |
| 96pcs | 96pcs |

1/6



| | | |
|-------------|------------------|------------------|
| CODE: | HA 06100 | HA 06150 |
| DIMENSIONS: | L171xW156xH100mm | L173xW158xH150mm |
| CAPACITY: | 1.53L | 2.27L |
| CASE PACK: | 84pcs | 102pcs |

| | |
|------------------|---------------------|
| HA06A(PP) | HA06B(PC) |
| L175xW160xH9.6mm | L176.6xW161.6xH17mm |
| \ | \ |
| 144pcs | 144pcs |

SQUARE FOOD STORAGE CONTAINER

The label is wipeable and repetition

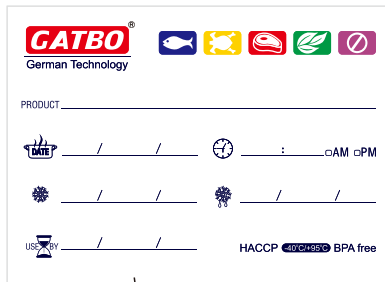

Label for easy food identification.
Color graduations for measurement.
Handle design for easy movement.
Stackable design to save space.

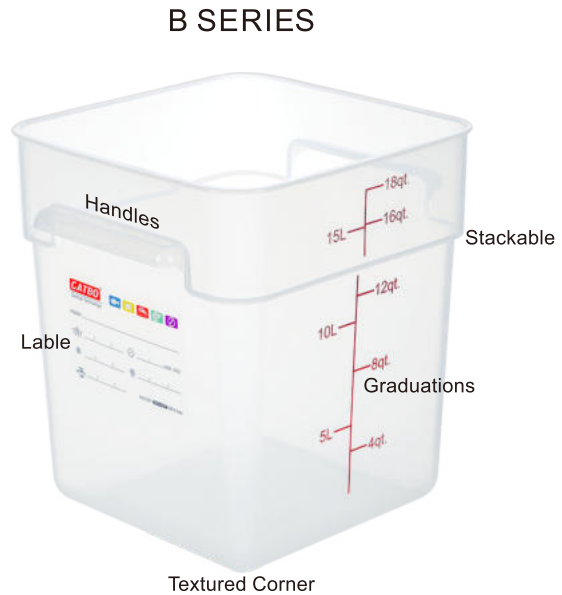
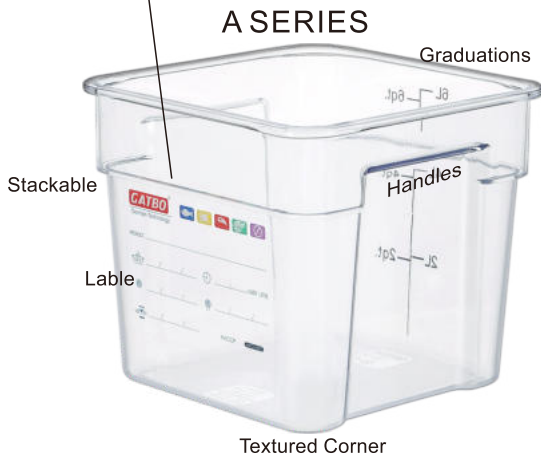

| DESCRIPTION | A Series | B Series |
|--|----------|------------|
| Concealed handles help save space | ✓ | |
| Revealed handles make carrying easy | | ✓ (12~22L) |
| This wipeable, reusable label supports quick inventory management. | ✓ | ✓ |
| Both engraved and color-printed graduation marks are adopted for quick inventory management, ensuring they remain readable over an extended period | ✓ | ✓ |
| Containers are made of PC/PP/PE | ✓ | ✓ |
| Airtight Lid | ✓ | |
| Seal lid | ✓ | |
| PE Lid | ✓ | ✓ |

SQUARE FOOD STORAGE CONTAINER(PC)

Note: All graduations are approximate.



PE COVER 4 colors optional. MOQ: 500pcs/color.

CAPACITY: 2~4L



| | | | | | |
|-------------|-----------------|------------------|-----------------|-----------------|-----------------|
| CODE: | KS2A-PC1 | KS4A-PC1 | KS22A-1PP | KS22A-2PE | KS22A-4PP |
| DIMENSIONS: | L225xW225xH65mm | L225xW225xH125mm | L225xW225xH22mm | L232xW232xH15mm | L270xW270xH15mm |
| CAPACITY: | 2L | 4L | \ | \ | \ |
| CASE PACK: | 48pcs | 24pcs | 72pcs | 96pcs | 72pcs |



| | | | | | |
|-------------|------------------|------------------|-----------------|-----------------|-----------------|
| CODE: | KS2A-PC | KS4A-PC | KS18A-1PP | KS18A-2PE | KS18A-4PP |
| DIMENSIONS: | L185xW185xH104mm | L186xW186xH211mm | L185xW185xH22mm | L192xW192xH15mm | L232xW232xH15mm |
| CAPACITY: | 2L | 4L | \ | \ | \ |
| CASE PACK: | 48pcs | 24pcs | 72pcs | 96pcs | 96pcs |



| | | | |
|-------------|-----------------|------------------|-----------------|
| CODE: | KS2B-PC | KS4B-PC | KS18B-2PE |
| DIMENSIONS: | L182xW182xH95mm | L182xW182xH182mm | L189xW189xH15mm |
| CAPACITY: | 1.9L | 3.8L | \ |
| CASE PACK: | 36pcs | 36pcs | 96pcs |



CAPACITY: 6~10L



| | | | | | | |
|-------------|------------------|------------------|------------------|-----------------|-----------------|-----------------|
| CODE: | KS6A-PC | KS8A-PC | KS10A-PC | KS22A-1PP | KS22A-2PE | KS22A-4PP |
| DIMENSIONS: | L224xW224xH198mm | L224xW224xH260mm | L225xW225xH335mm | L225xW225xH22mm | L232xW232xH15mm | L270xW270xH15mm |
| CAPACITY: | 6L | 8L | 10L | \ | \ | \ |
| CASE PACK: | 24pcs | 12pcs | 6pcs | 72pcs | 96pcs | 72pcs |



| | | | |
|-------------|------------------|------------------|-----------------|
| CODE: | KS6B-PC | KS8B-PC | KS22B-2PE |
| DIMENSIONS: | L220xW220xH180mm | L220xW220xH229mm | L227xW227xH13mm |
| CAPACITY: | 5.7L | 7.6L | \ |
| CASE PACK: | 24pcs | 24pcs | 96pcs |





SQUARE FOOD STORAGE CONTAINER(PC)

Note: All graduations are approximate.

CAPACITY: 12~22L



PE COVER 4 colors optional. MOQ: 500pcs/color.

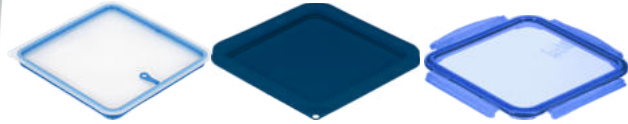

| | | | | | | |
|-------------|------------------|------------------|------------------|-----------------|-----------------|-----------------|
| CODE: | KS12A-PC | KS18A-PC | KS22A-PC | KS28A-1PP | KS28A-2PE | KS28A-4PP |
| DIMENSIONS: | L280xW280xH228mm | L280xW280xH346mm | L280xW280xH426mm | L280xW280xH22mm | L288xW288xH15mm | L330xW330xH15mm |
| CAPACITY: | 12L | 18L | 22L | \ | \ | \ |
| CASE PACK: | 6pcs | 6pcs | 6pcs | 48pcs | 72pcs | 60pcs |



| | | | | |
|-------------|------------------|------------------|------------------|-----------------|
| CODE: | KS12B-PC | KS18B-PC | KS22B-PC | KS28B-2PE |
| DIMENSIONS: | L312xW282xH208mm | L312xW282xH320mm | L313xW282xH398mm | L288xW288xH15mm |
| CAPACITY: | 11.4L | 17.2L | 20.8L | \ |
| CASE PACK: | 6pcs | 6pcs | 6pcs | 72pcs |



SQUARE FOOD STORAGE CONTAINER(PP)

Note: All graduations are approximate.

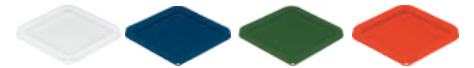

PE COVER4 colors optional. MOQ: 500pcs/color.

CAPACITY: 2~4L



| | | | | | |
|-------------|-----------------|------------------|-----------------|-----------------|-----------------|
| CODE: | KS2A-PP1 | KS4A-PP1 | KS22A-1PP | KS22A-2PE | KS22A-4PP |
| DIMENSIONS: | L225xW225xH65mm | L225xW225xH125mm | L225xW225xH22mm | L232xW232xH15mm | L270xW270xH15mm |
| CAPACITY: | 2L | 4L | \ | \ | \ |
| CASE PACK: | 48pcs | 24pcs | 72pcs | 96pcs | 72pcs |



| | | | | | |
|-------------|------------------|------------------|-----------------|-----------------|-----------------|
| CODE: | KS2A-PP | KS4A-PP | KS18A-1PP | KS18A-2PE | KS18A-4PP |
| DIMENSIONS: | L185xW185xH104mm | L186xW186xH211mm | L185xW185xH22mm | L192xW192xH15mm | L232xW232xH15mm |
| CAPACITY: | 2L | 4L | \ | \ | \ |
| CASE PACK: | 48pcs | 24pcs | 72pcs | 96pcs | 96pcs |



| | | | |
|-------------|-----------------|------------------|-----------------|
| CODE: | KS2B-PP | KS4B-PP | KS18B-2PE |
| DIMENSIONS: | L182xW182xH95mm | L182xW182xH182mm | L189xW189xH15mm |
| CAPACITY: | 1.9LL | 3.8L | \ |
| CASE PACK: | 36pcs | 36pcs | 96pcs |

CAPACITY: 6~10L



| | | | | | | |
|-------------|------------------|------------------|------------------|-----------------|-----------------|-----------------|
| CODE: | KS6A-PP | KS8A-PP | KS10A-PP | KS22A-1PP | KS22A-2PE | KS22A-4PP |
| DIMENSIONS: | L224xW224xH198mm | L224xW224xH260mm | L225xW225xH335mm | L225xW225xH22mm | L232xW232xH15mm | L270xW270xH15mm |
| CAPACITY: | 6L | 8L | 10L | \ | \ | \ |
| CASE PACK: | 24pcs | 12pcs | 6pcs | 72pcs | 96pcs | 72pcs |



| | | | |
|-------------|------------------|------------------|-----------------|
| CODE: | KS6B-PP | KS8B-PP | KS22B-2PE |
| DIMENSIONS: | L220xW220xH180mm | L220xW220xH229mm | L227xW227xH13mm |
| CAPACITY: | 5.7L | 7.6L | \ |
| CASE PACK: | 24pcs | 24pcs | 96pcs |





SQUARE FOOD STORAGE CONTAINER(PP)

Note:All graduations are approximate.

CAPACITY: 12~22L



PE COVER4 colors optional. MOQ: 500pcs/color.



| | | | | | | |
|-------------|------------------|------------------|------------------|-----------------|-----------------|-----------------|
| CODE: | KS12A-PP | KS18A-PP | KS22A-PP | KS28A-1PP | KS28A-2PE | KS28A-4PP |
| DIMENSIONS: | L280xW280xH228mm | L280xW280xH346mm | L280xW280xH427mm | L280xW280xH22mm | L288xW288xH15mm | L330xW330xH15mm |
| CAPACITY: | 12L | 18L | 22L | \ | \ | \ |
| CASE PACK: | 6pcs | 6pcs | 6pcs | 48pcs | 72pcs | 60pcs |

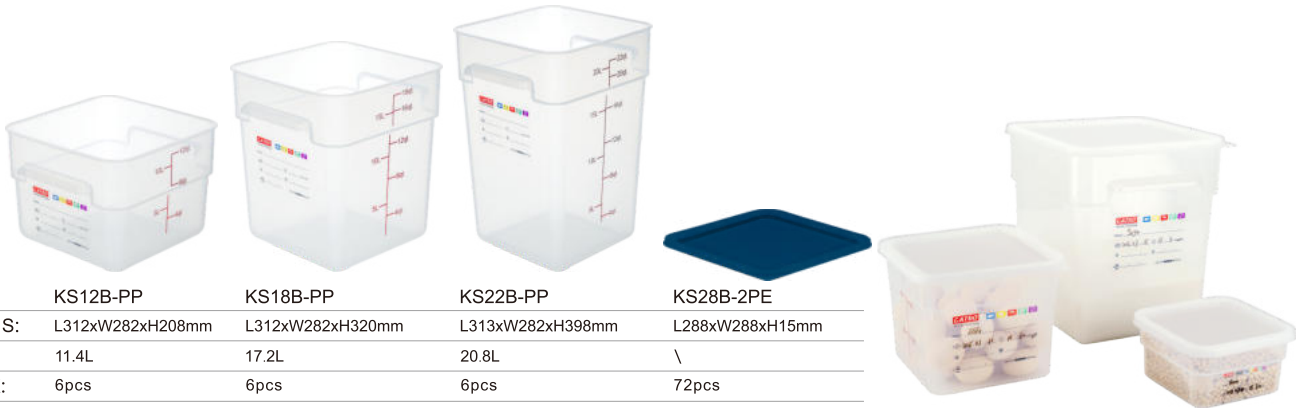

| | | | | |
|-------------|------------------|------------------|------------------|-----------------|
| CODE: | KS12B-PP | KS18B-PP | KS22B-PP | KS28B-2PE |
| DIMENSIONS: | L312xW282xH208mm | L312xW282xH320mm | L313xW282xH398mm | L288xW288xH15mm |
| CAPACITY: | 11.4L | 17.2L | 20.8L | \ |
| CASE PACK: | 6pcs | 6pcs | 6pcs | 72pcs |

SQUARE STORAGE CONTAINER(PE)

CAPACITY: 12~22L



| | | | | |
|-------------|------------------|------------------|------------------|-----------------|
| CODE: | KS12B-PE | KS18B-PE | KS22B-PE | KS28B-2PE |
| DIMENSIONS: | L312xW282xH208mm | L312xW282xH320mm | L313xW282xH398mm | L288xW288xH15mm |
| CAPACITY: | 11.4L | 17.2L | 20.8L | \ |
| CASE PACK: | 6pcs | 6pcs | 6pcs | 72pcs |



ROUND FOOD STORAGE CONTAINERS

Note: All graduations are approximate.

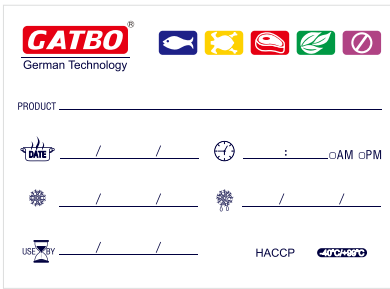

The label is wipeable and repetition



| | | | | | |
|-------------|------------------------|------------------------|------------------------|----------------------|----------------------|
| CODE: | KR22B-PC | KR18B-PC | KR12B-PC | KR8B-PC | KR6B-PC |
| DIMENSIONS: | L348xW332xH379mm | L350xW315xH305mm | L350xW315xH210mm | L255xW224xH272mm | L255xW224xH197mm |
| CAPACITY: | 20.8L | 17.2L | 11.4L | 7.6L | 5.7L |
| CASE PACK: | 6pcs | 6pcs | 6pcs | 12pcs | 12pcs |
| FIT: | KR12B-2PC KR12B-2PE | KR12B-2PC KR12B-2PE | KR12B-2PC KR12B-2PE | KR6B-6PC KR6B-2PE | KR6B-6PC KR6B-2PE |

MATERIAL:PC



| | | | |
|-------------|----------------------|----------------------|----------------------|
| CODE: | KR4B-PC | KR2B-PC | KR1B-PC |
| DIMENSIONS: | L207xW182xH214mm | L207xW182xH109mm | L157xW129xH126mm |
| CAPACITY: | 3.8L | 1.9L | 0.9L |
| CASE PACK: | 36pcs | 36pcs | 36pcs |
| FIT: | KR2B-6PC KR2B-2PE | KR2B-6PC KR2B-2PE | KR1B-6PC KR1B-2PE |

MATERIAL:PC



| | | | | |
|-------------|-----------------|----------------|----------------|----------------|
| CODE: | KR12B-2PC | KR6B-6PC | KR2B-6PC | KR1B-6PC |
| DIMENSIONS: | L330xW320xH18mm | L236xW228xH8mm | L193xW185xH8mm | L141xW133xH8mm |
| CASE PACK: | 30pcs | 96pcs | 96pcs | 96pcs |

MATERIAL:PC



ROUND FOOD STORAGE CONTAINERS

Note: All graduations are approximate.
Material options for this series: PE



| | | | | | |
|-------------|------------------|------------------|------------------|------------------|------------------|
| CODE: | KR22B-PP | KR18B-PP | KR12B-PP | KR8B-PP | KR6B-PP |
| DIMENSIONS: | L348xW332xH379mm | L351xW267xH305mm | L350xW315xH210mm | L225xW224xH272mm | L225xW224xH197mm |
| CAPACITY: | 20.8L | 17.2L | 11.4L | 7.6L | 5.7L |
| CASE PACK: | 6pcs | 6pcs | 6pcs | 12pcs | 12pcs |
| FIT: | KR12B-2PE | KR12B-2PE | KR12B-2PE | KR6B-7PE | KR6B-7PE |

MATERIAL:PP



| | | | |
|-------------|------------------|------------------|------------------|
| CODE: | KR4B-PP | KR2B-PP | KR1B-PP |
| DIMENSIONS: | L207xW182xH214mm | L207xW182xH109mm | L157xW129xH126mm |
| CAPACITY: | 3.8L | 1.9L | 0.9L |
| CASE PACK: | 36pcs | 36pcs | 36pcs |
| FIT: | KR2B-2PE | KR2B-2PE | KR1B-2PE |

MATERIAL:PP



| | | | | |
|-------------|-----------------|----------------|----------------|----------------|
| CODE: | KR12B-2PE | KR6B-2PE | KR2B-2PE | KR1B-2PE |
| DIMENSIONS: | L330xW320xH18mm | L236xW228xH8mm | L193xW185xH8mm | L141xW133xH8mm |
| CASE PACK: | 24pcs | 96pcs | 96pcs | 96pcs |

MATERIAL:PE



FOOD STORAGE BOXES



| | | | | | |
|-------------|----------------------|--------------------|--------------------|--------------------|-----------------|
| CODE: | KS182615-PC | KS182612-PC | KS18269-PC | KS18266-PC | KS18263-PC |
| DIMENSIONS: | L658.5xW456xH376.5mm | L658.5xW456xH304mm | L658.5xW456xH225mm | L658.5xW456xH149mm | L661xW457xH88mm |
| CAPACITY: | 83.2L | 64.4L | 49.2L | 33.1L | 18.9L |
| CASE PACK: | 3pcs | 4pcs | 4pcs | 6pcs | 6pcs |



| | | | | | |
|-------------|-----------------|-------------------|------------------|------------------|-----------------|
| CODE: | KS1826-9PC | KS1826-8PC | KSW18268-PC | KSW18265-PC | KSD1826-PC |
| DIMENSIONS: | L657xW454xH38mm | L660xW457.5xH33mm | L656xW455xH219mm | L656xW456xH135mm | L555xW356xH16mm |
| CASE PACK: | 18pcs | 18pcs | 6pcs | 6pcs | 18pcs |



| | | | | | |
|-------------|-----------------|-------------------|------------------|------------------|-----------------|
| CODE: | KSD1218-PC | KS1218-8PC | KS12189-PC | KS12186-PC | KS12183-PC |
| DIMENSIONS: | L352xW203xH16mm | L456xW303.5xH32mm | L456xW304xH227mm | L456xW304xH152mm | L456xW304xH88mm |
| CAPACITY: | \ | \ | 18.7L | 11.3L | 6.6L |
| CASE PACK: | 18pcs | 24pcs | 6pcs | 6pcs | 18pcs |

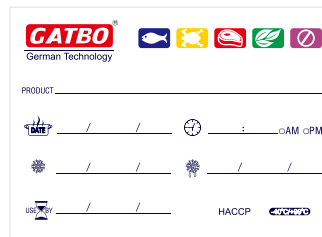

Slid Lid: Easy Access to Contents
The Label is wipeable and repetitive.



Drain shelf and conlander: separates food and liquid, which helps preserve food quality.



INGREDIENT BOX

Product Features:

- Store bulk dry materials like flour, grains.
- Rewritable stickers, clearly show the product info like raw material exp. Date on the box, meet the requirements of food management.
- Store food in stackable bins to save space.
- Special slide lid, fixable and suspensible; Easy open, work better.
- Scoops are inside the bins but not touch the ingredient, easy to pick.
- Transparent lid, quickly recognize material types and manage inventory.
- Inner smooth, clean easy, no dirt.
- Made by quality PP material, non-toxic, odorless, strong and durable.
- Meet NSF standards.



| CODE: | KU10B | KU23B | KU47B |
|-------------|---------------|---------------|---------------|
| MATERIALS : | PP | PP | PP |
| DIMENSIONS: | 380x300x215mm | 584x291x430mm | 598x487x440mm |
| CAPACITY: | 10L | 23L | 47L |
| CASE PACK: | 2PCS | 2PCS | 1PCS |

ACCESSORIES:
SCOOP  K9070-PC x1

 K9070-PC x1

 K9066-PC x1

INGREDIENT BINS

Product Features:

- Store bulk dry materials like flour, grains.
- Rewritable stickers, clearly show the product info like raw material exp. Date on the box, meet the requirements of food management.
- Store food in stackable bins to save space.
- Special slide lid, easy open, work better.
- Scoops are inside the bins but not touch the ingredient, easy to pick.
- Transparent lid, quickly recognize material types and manage inventory.
- "First in, first out" for food flow, keep quality.
- Inner smooth, clean easy, no dirt.
- Made by PP material, non-toxic, odorless, strong and durable.
- Four-wheel casters with brakes make the bin moving easily in different working place, safe and convenient use.
- Designed to fit under standard work tables.

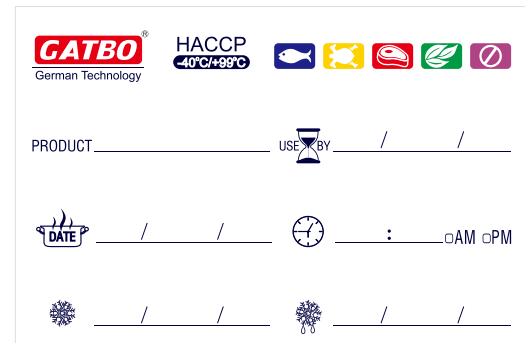

The label is wipeable and repetition

| CODE: | KU80A | KU100A | KU120A |
|-------------|-----------------|---------------|---------------|
| DIMENSIONS: | 332x740x746.5mm | 750x394x751mm | 757x454x746mm |
| CAPACITY: | 84.54 L | 106.8 L | 125L |
| CASE PACK: | 1PCS | 1PCS | 1PCS |



INGREDIENT BINS

- **Effortless Twist Cap Design**

Easy to Open ,Quick Dispensing & Refilling Smoother than Snap/Flip Caps, Boost Food Prep Efficiency

- **Semi-Transparent PC Twist Cap**

See Remaining Ingredients Without Opening Real-Time Stock Tracking ,Avoid Prep Shortages

- **3 Sizes to Fit All Your Storage Needs**

Small: Perfect for spices and dried snacks
 Medium: Ideal for rice, flour, and grains
 Large: Great for cooking oil and bulk supplies

- **Built-in Reusable Writable Label**

Mark Ingredients, Dates & Shelf Life Directly Wear-Resistant & Non-Peeling, No Extra Labels Needed



The label is wipeable and repetition



| CODE: | KU35-W | KU80-W | KU120-W |
|-------------|------------------|------------------|------------------|
| DIMENSIONS: | L470xW391xH446mm | L563xW510xH580mm | L559xW627xH700mm |
| CAPACITY: | 35L | 80L | 120L |
| CASE PACK: | 6PCS | 6PCS | 6PCS |



| CODE: | KU-1W | KU-2W | KU-3W |
|-------------|------------|------------|------------|
| DIMENSIONS: | D422xH73mm | D535xH73mm | D590xH73mm |
| CASE PACK: | 12PCS | 6PCS | 6PCS |

TRANSFER CONTAINER

- Double handles make transport easy.
- Stacking can save space when not in use.

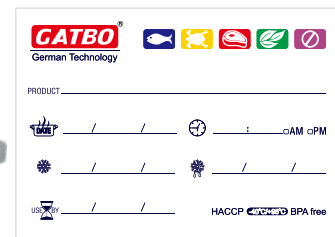

The label is wipeable and repetition

| | | |
|-------------|------------------------------|-----------------------------|
| CODE: | KN724228-G (Includes cover) | KN724238-G (Includes cover) |
| MATERIALS : | PP | PP |
| DIMENSIONS: | 720x426x286mm | 720x426x390mm |
| CAPACITY: | 59L | 79L |
| CASE PACK: | 6pcs | 6pcs |



K-LarderPro

KL SHELVING-PREMIUM SERIES

STATIONARY | MOBILE | UNDERCOUNTER

Durable composite material.
 Smooth surface, easy to clean.
 Independent accessories for easy adjustment and replacement.
 Easy and fast to set up,
 Increases storage capacity up to 60%



Stationary Installation Video



Mobile Installation Video



STARTER UNITS

Units ship complete in 2 boxes: shelf plates & accessories in one, post kits & traverses in the other.

Starter unit size

| DEPTHS (mm) | LENGTHS (mm) | | HEIGHT (mm) |
|-------------|--------------|-------------|-------------|
| 460 | 610 | 1220 | 1630 |
| 540 | 765 | 1375 | 1830 |
| 610 | 915 | 1525 | 2140 |
| | 1070 | 1830 | |

Standard mobile unit size

| DEPTHS (mm) | LENGTHS (mm) | | HEIGHT (mm) |
|-------------|--------------|-------------|-------------|
| 460 | 915 | 1375 | 1784 |
| 540 | 1070 | 1525 | 1987 |
| 610 | 1220 | 1830 | |

Under-table unit size

| DEPTHS (mm) | LENGTHS (mm) | HEIGHT (mm) |
|-------------|---------------------------|-------------|
| 460 | 915 1220 | 765 |

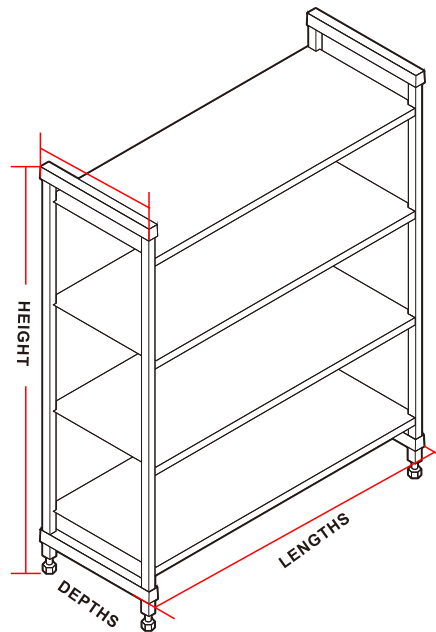

Weight bearing

The weight must be evenly distributed across the entire shelf.

| | | UNIT LENGTH | |
|--|----------------------------------|-------------|---------|
| | | 610 -1525MM | 1830 MM |
| SINGLE UNIT | Unit only | 1090 kg | 1090 kg |
| | Shelf only | 365 | 275 |
| | Unit with dunnage stand | 1270 | 1225 |
| | Bottom shelf with dunnage stand | 545 | 410 |
| | | UNIT LENGTH | |
| | | 610 -1525MM | |
| CORNER UNIT with 2 Dunnage stands required | Unit only | 1090 | |
| | Shelf only | 365 | |
| | Bottom shelf with dunnage stands | 545 | |
| | | UNIT LENGTH | |
| | | 610 -1525MM | |
| INTERMEDIATE UNIT with 2 Dunnage stands required | Unit only | 1090 | |
| | Shelf only | 365 | |
| | Bottom shelf with dunnage stands | 545 | |
| MOBILE UNIT | Unit only | 340 | |

Dunnage Stands add stability and increase weight bearing capacity on bottom shelf only. For use with shelves of any length. Highly recommended for Starter Units 1375mm and longer, all Corner Units, U-Shape Units and units specified for heavier loads.

Due to the weight bearing capacity of casters, maximum weight load on an entire Mobile Unit is 340KG.

V4

4-SHELF VENTED UNITS

1630
mm
HEIGHT

Starter units include 2 factory assembled stationary post kits, stationary traverses, stationary traverse dovetails and shelf plates.
Add-On units include 1 factory assembled stationary post kit, stationary traverses, stationary traverse dovetails and shelf plates. Units ship complete in 2 boxes.

Starter



460_{mm}
DEPTHS

| LENGTHS | CODE |
|---------|-------------|
| 610mm | KLU182464V4 |
| 765 | KLU183064V4 |
| 915 | KLU183664V4 |
| 1070 | KLU184264V4 |
| 1220 | KLU184864V4 |
| 1375 | KLU185464V4 |
| 1525 | KLU186064V4 |
| 1830 | KLU187264V4 |

Add-on

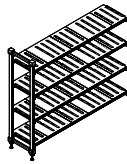

| LENGTHS | CODE |
|---------|-------------|
| 559mm | KLA182464V4 |
| 712 | KLA183064V4 |
| 864 | KLA183664V4 |
| 1016 | KLA184264V4 |
| 1169 | KLA184864V4 |
| 1321 | KLA185464V4 |
| 1474 | KLA186064V4 |
| 1778 | KLA187264V4 |

V5

5-SHELF VENTED UNITS

460_{mm}
DEPTHS

| LENGTHS | CODE |
|---------|-------------|
| 610mm | KLU182464V5 |
| 765 | KLU183064V5 |
| 915 | KLU183664V5 |
| 1070 | KLU184264V5 |
| 1220 | KLU184864V5 |
| 1375 | KLU185464V5 |
| 1525 | KLU186064V5 |
| 1830 | KLU187264V5 |

Add-on

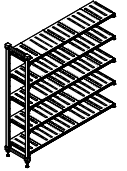

| LENGTHS | CODE |
|---------|-------------|
| 559mm | KLA182464V5 |
| 712 | KLA183064V5 |
| 864 | KLA183664V5 |
| 1016 | KLA184264V5 |
| 1169 | KLA184864V5 |
| 1321 | KLA185464V5 |
| 1474 | KLA186064V5 |
| 1778 | KLA187264V5 |

540_{mm}
DEPTHS

| LENGTHS | CODE |
|---------|-------------|
| 610mm | KLU212464V4 |
| 765 | KLU213064V4 |
| 915 | KLU213664V4 |
| 1070 | KLU214264V4 |
| 1220 | KLU214864V4 |
| 1375 | KLU215464V4 |
| 1525 | KLU216064V4 |
| 1830 | KLU217264V4 |

| LENGTHS | CODE |
|---------|-------------|
| 559mm | KLA212464V4 |
| 712 | KLA213064V4 |
| 864 | KLA213664V4 |
| 1016 | KLA214264V4 |
| 1169 | KLA214864V4 |
| 1321 | KLA215464V4 |
| 1474 | KLA216064V4 |
| 1778 | KLA217264V4 |

540_{mm}
DEPTHS

| LENGTHS | CODE |
|---------|-------------|
| 610mm | KLU212464V5 |
| 765 | KLU213064V5 |
| 915 | KLU213664V5 |
| 1070 | KLU214264V5 |
| 1220 | KLU214864V5 |
| 1375 | KLU215464V5 |
| 1525 | KLU216064V5 |
| 1830 | KLU217264V5 |

| LENGTHS | CODE |
|---------|-------------|
| 559mm | KLA212464V5 |
| 712 | KLA213064V5 |
| 864 | KLA213664V5 |
| 1016 | KLA214264V5 |
| 1169 | KLA214864V5 |
| 1321 | KLA215464V5 |
| 1474 | KLA216064V5 |
| 1778 | KLA217264V5 |

610_{mm}
DEPTHS

| LENGTHS | CODE |
|---------|-------------|
| 610mm | KLU242464V4 |
| 765 | KLU243064V4 |
| 915 | KLU243664V4 |
| 1070 | KLU244264V4 |
| 1220 | KLU244864V4 |
| 1375 | KLU245464V4 |
| 1525 | KLU246064V4 |
| 1830 | KLU247264V4 |

| LENGTHS | CODE |
|---------|-------------|
| 559mm | KLA242464V4 |
| 712 | KLA243064V4 |
| 864 | KLA243664V4 |
| 1016 | KLA244264V4 |
| 1169 | KLA244864V4 |
| 1321 | KLA245464V4 |
| 1474 | KLA246064V4 |
| 1778 | KLA247264V4 |

610_{mm}
DEPTHS

| LENGTHS | CODE |
|---------|-------------|
| 610mm | KLU242464V5 |
| 765 | KLU243064V5 |
| 915 | KLU243664V5 |
| 1070 | KLU244264V5 |
| 1220 | KLU244864V5 |
| 1375 | KLU245464V5 |
| 1525 | KLU246064V5 |
| 1830 | KLU247264V5 |

| LENGTHS | CODE |
|---------|-------------|
| 559mm | KLA242464V5 |
| 712 | KLA243064V5 |
| 864 | KLA243664V5 |
| 1016 | KLA244264V5 |
| 1169 | KLA244864V5 |
| 1321 | KLA245464V5 |
| 1474 | KLA246064V5 |
| 1778 | KLA247264V5 |

Color: Speckled Gray

S4

4-SHELF SOLID UNITS

1630
mm
HEIGHT

Starter units include 2 factory assembled stationary post kits, stationary traverses, stationary traverse dovetails and shelf plates.
Add-On units include 1 factory assembled stationary post kit, stationary traverses, stationary traverse dovetails and shelf plates. Units ship complete in 2 boxes.

Starter



460_{mm}
DEPTHS

| LENGTHS | CODE |
|---------|-------------|
| 610mm | KLU182464S4 |
| 765 | KLU183064S4 |
| 915 | KLU183664S4 |
| 1070 | KLU184264S4 |
| 1220 | KLU184864S4 |
| 1375 | KLU185464S4 |
| 1525 | KLU186064S4 |
| 1830 | KLU187264S4 |

Add-on



| LENGTHS | CODE |
|---------|-------------|
| 559mm | KLA182464S4 |
| 712 | KLA183064S4 |
| 864 | KLA183664S4 |
| 1016 | KLA184264S4 |
| 1169 | KLA184864S4 |
| 1321 | KLA185464S4 |
| 1474 | KLA186064S4 |
| 1778 | KLA187264S4 |

540_{mm}
DEPTHS

| LENGTHS | CODE |
|---------|-------------|
| 610mm | KLU212464S4 |
| 765 | KLU213064S4 |
| 915 | KLU213664S4 |
| 1070 | KLU214264S4 |
| 1220 | KLU214864S4 |
| 1375 | KLU215464S4 |
| 1525 | KLU216064S4 |
| 1830 | KLU217264S4 |

| LENGTHS | CODE |
|---------|-------------|
| 559mm | KLA212464S4 |
| 712 | KLA213064S4 |
| 864 | KLA213664S4 |
| 1016 | KLA214264S4 |
| 1169 | KLA214864S4 |
| 1321 | KLA215464S4 |
| 1474 | KLA216064S4 |
| 1778 | KLA217264S4 |

610_{mm}
DEPTHS

| LENGTHS | CODE |
|---------|-------------|
| 610mm | KLU242464S4 |
| 765 | KLU243064S4 |
| 915 | KLU243664S4 |
| 1070 | KLU244264S4 |
| 1220 | KLU244864S4 |
| 1375 | KLU245464S4 |
| 1525 | KLU246064S4 |
| 1830 | KLU247264S4 |

| LENGTHS | CODE |
|---------|-------------|
| 559mm | KLA242464S4 |
| 712 | KLA243064S4 |
| 864 | KLA243664S4 |
| 1016 | KLA244264S4 |
| 1169 | KLA244864S4 |
| 1321 | KLA245464S4 |
| 1474 | KLA246064S4 |
| 1778 | KLA247264S4 |

S5

5-SHELF SOLID UNITS

460_{mm}
DEPTHS

| LENGTHS | CODE |
|---------|-------------|
| 610mm | KLU182464S5 |
| 765 | KLU183064S5 |
| 915 | KLU183664S5 |
| 1070 | KLU184264S5 |
| 1220 | KLU184864S5 |
| 1375 | KLU185464S5 |
| 1525 | KLU186064S5 |
| 1830 | KLU187264S5 |

Add-on

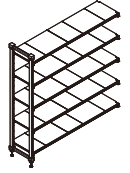

| LENGTHS | CODE |
|---------|-------------|
| 559mm | KLA182464S5 |
| 712 | KLA183064S5 |
| 864 | KLA183664S5 |
| 1016 | KLA184264S5 |
| 1169 | KLA184864S5 |
| 1321 | KLA185464S5 |
| 1474 | KLA186064S5 |
| 1778 | KLA187264S5 |

540_{mm}
DEPTHS

| LENGTHS | CODE |
|---------|-------------|
| 610mm | KLU212464S5 |
| 765 | KLU213064S5 |
| 915 | KLU213664S5 |
| 1070 | KLU214264S5 |
| 1220 | KLU214864S5 |
| 1375 | KLU215464S5 |
| 1525 | KLU216064S5 |
| 1830 | KLU217264S5 |

| LENGTHS | CODE |
|---------|-------------|
| 559mm | KLA212464S5 |
| 712 | KLA213064S5 |
| 864 | KLA213664S5 |
| 1016 | KLA214264S5 |
| 1169 | KLA214864S5 |
| 1321 | KLA215464S5 |
| 1474 | KLA216064S5 |
| 1778 | KLA217264S5 |

610_{mm}
DEPTHS

| LENGTHS | CODE |
|---------|-------------|
| 610mm | KLU242464S5 |
| 765 | KLU243064S5 |
| 915 | KLU243664S5 |
| 1070 | KLU244264S5 |
| 1220 | KLU244864S5 |
| 1375 | KLU245464S5 |
| 1525 | KLU246064S5 |
| 1830 | KLU247264S5 |

| LENGTHS | CODE |
|---------|-------------|
| 559mm | KLA242464S5 |
| 712 | KLA243064S5 |
| 864 | KLA243664S5 |
| 1016 | KLA244264S5 |
| 1169 | KLA244864S5 |
| 1321 | KLA245464S5 |
| 1474 | KLA246064S5 |
| 1778 | KLA247264S5 |

Color: Speckled Gray

V4

V5

4-SHELF VENTED UNITS

5-SHELF VENTED UNITS

1830

mm
HEIGHT

Starter units include 2 factory assembled stationary post kits, stationary traverses, stationary traverse dovetails and shelf plates.

Add-On units include 1 factory assembled stationary post kit, stationary traverses, stationary traverse dovetails and shelf plates. Units ship complete in 2 boxes.

Starter



460mm
DEPTHS

| LENGTHS | CODE |
|---------|-------------|
| 610mm | KLU182472V4 |
| 765 | KLU183072V4 |
| 915 | KLU183672V4 |
| 1070 | KLU184272V4 |
| 1220 | KLU184872V4 |
| 1375 | KLU185472V4 |
| 1525 | KLU186072V4 |
| 1830 | KLU187272V4 |

Add-on

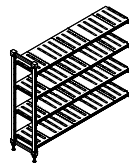

| LENGTHS | CODE |
|---------|-------------|
| 559mm | KLA182472V4 |
| 712 | KLA183072V4 |
| 864 | KLA183672V4 |
| 1016 | KLA184272V4 |
| 1169 | KLA184872V4 |
| 1321 | KLA185472V4 |
| 1474 | KLA186072V4 |
| 1778 | KLA187272V4 |

Starter

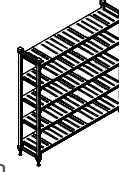

460mm
DEPTHS

| LENGTHS | CODE |
|---------|-------------|
| 610mm | KLU182472V5 |
| 765 | KLU183072V5 |
| 915 | KLU183672V5 |
| 1070 | KLU184272V5 |
| 1220 | KLU184872V5 |
| 1375 | KLU185472V5 |
| 1525 | KLU186072V5 |
| 1830 | KLU187272V5 |

Add-on

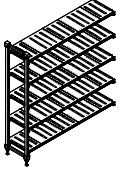

| LENGTHS | CODE |
|---------|-------------|
| 559mm | KLA182472V5 |
| 712 | KLA183072V5 |
| 864 | KLA183672V5 |
| 1016 | KLA184272V5 |
| 1169 | KLA184872V5 |
| 1321 | KLA185472V5 |
| 1474 | KLA186072V5 |
| 1778 | KLA187272V5 |

540mm
DEPTHS

| LENGTHS | CODE |
|---------|-------------|
| 610mm | KLU212472V4 |
| 765 | KLU213072V4 |
| 915 | KLU213672V4 |
| 1070 | KLU214272V4 |
| 1220 | KLU214872V4 |
| 1375 | KLU215472V4 |
| 1525 | KLU216072V4 |
| 1830 | KLU217272V4 |

| LENGTHS | CODE |
|---------|-------------|
| 559mm | KLA212472V4 |
| 712 | KLA213072V4 |
| 864 | KLA213672V4 |
| 1016 | KLA214272V4 |
| 1169 | KLA214872V4 |
| 1321 | KLA215472V4 |
| 1474 | KLA216072V4 |
| 1778 | KLA217272V4 |

540mm
DEPTHS

| LENGTHS | CODE |
|---------|-------------|
| 610mm | KLU212472V5 |
| 765 | KLU213072V5 |
| 915 | KLU213672V5 |
| 1070 | KLU214272V5 |
| 1220 | KLU214872V5 |
| 1375 | KLU215472V5 |
| 1525 | KLU216072V5 |
| 1830 | KLU217272V5 |

| LENGTHS | CODE |
|---------|-------------|
| 559mm | KLA212472V5 |
| 712 | KLA213072V5 |
| 864 | KLA213672V5 |
| 1016 | KLA214272V5 |
| 1169 | KLA214872V5 |
| 1321 | KLA215472V5 |
| 1474 | KLA216072V5 |
| 1778 | KLA217272V5 |

610mm
DEPTHS

| LENGTHS | CODE |
|---------|-------------|
| 610mm | KLU242472V4 |
| 765 | KLU243072V4 |
| 915 | KLU243672V4 |
| 1070 | KLU244272V4 |
| 1220 | KLU244872V4 |
| 1375 | KLU245472V4 |
| 1525 | KLU246072V4 |
| 1830 | KLU247272V4 |

| LENGTHS | CODE |
|---------|-------------|
| 559mm | KLA242472V4 |
| 712 | KLA243072V4 |
| 864 | KLA243672V4 |
| 1016 | KLA244272V4 |
| 1169 | KLA244872V4 |
| 1321 | KLA245472V4 |
| 1474 | KLA246072V4 |
| 1778 | KLA247272V4 |

610mm
DEPTHS

| LENGTHS | CODE |
|---------|-------------|
| 610mm | KLU242472V5 |
| 765 | KLU243072V5 |
| 915 | KLU243672V5 |
| 1070 | KLU244272V5 |
| 1220 | KLU244872V5 |
| 1375 | KLU245472V5 |
| 1525 | KLU246072V5 |
| 1830 | KLU247272V5 |

| LENGTHS | CODE |
|---------|-------------|
| 559mm | KLA242472V5 |
| 712 | KLA243072V5 |
| 864 | KLA243672V5 |
| 1016 | KLA244272V5 |
| 1169 | KLA244872V5 |
| 1321 | KLA245472V5 |
| 1474 | KLA246072V5 |
| 1778 | KLA247272V5 |

Color: Speckled Gray

S4

4-SHELF SOLID UNITS

1830

mm
HEIGHT

Starter units include 2 factory assembled stationary post kits, stationary traverses, stationary traverse dovetails and shelf plates.
Add-On units include 1 factory assembled stationary post kit, stationary traverses, stationary traverse dovetails and shelf plates. Units ship complete in 2 boxes.

Starter



460_{mm}
DEPTHS

| LENGTHS | CODE |
|---------|-------------|
| 610mm | KLU182472S4 |
| 765 | KLU183072S4 |
| 915 | KLU183672S4 |
| 1070 | KLU184272S4 |
| 1220 | KLU184872S4 |
| 1375 | KLU185472S4 |
| 1525 | KLU186072S4 |
| 1830 | KLU187272S4 |

Add-on

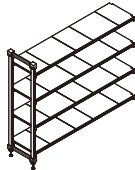

| LENGTHS | CODE |
|---------|-------------|
| 559mm | KLA182472S4 |
| 712 | KLA183072S4 |
| 864 | KLA183672S4 |
| 1016 | KLA184272S4 |
| 1169 | KLA184872S4 |
| 1321 | KLA185472S4 |
| 1474 | KLA186072S4 |
| 1778 | KLA187272S4 |

Starter

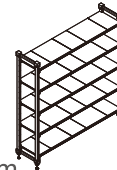

460_{mm}
DEPTHS

| LENGTHS | CODE |
|---------|-------------|
| 610mm | KLU182472S5 |
| 765 | KLU183072S5 |
| 915 | KLU183672S5 |
| 1070 | KLU184272S5 |
| 1220 | KLU184872S5 |
| 1375 | KLU185472S5 |
| 1525 | KLU186072S5 |
| 1830 | KLU187272S5 |

Add-on

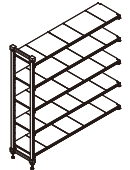

| LENGTHS | CODE |
|---------|-------------|
| 559mm | KLA182472S5 |
| 712 | KLA183072S5 |
| 864 | KLA183672S5 |
| 1016 | KLA184272S5 |
| 1169 | KLA184872S5 |
| 1321 | KLA185472S5 |
| 1474 | KLA186072S5 |
| 1778 | KLA187272S5 |

540_{mm}
DEPTHS

| LENGTHS | CODE |
|---------|-------------|
| 610mm | KLU212472S4 |
| 765 | KLU213072S4 |
| 915 | KLU213672S4 |
| 1070 | KLU214272S4 |
| 1220 | KLU214872S4 |
| 1375 | KLU215472S4 |
| 1525 | KLU216072S4 |
| 1830 | KLU217272S4 |

| LENGTHS | CODE |
|---------|-------------|
| 559mm | KLA212472S4 |
| 712 | KLA213072S4 |
| 864 | KLA213672S4 |
| 1016 | KLA214272S4 |
| 1169 | KLA214872S4 |
| 1321 | KLA215472S4 |
| 1474 | KLA216072S4 |
| 1778 | KLA217272S4 |

540_{mm}
DEPTHS

| LENGTHS | CODE |
|---------|-------------|
| 610mm | KLU212472S5 |
| 765 | KLU213072S5 |
| 915 | KLU213672S5 |
| 1070 | KLU214272S5 |
| 1220 | KLU214872S5 |
| 1375 | KLU215472S5 |
| 1525 | KLU216072S5 |
| 1830 | KLU217272S5 |

| LENGTHS | CODE |
|---------|-------------|
| 559mm | KLA212472S5 |
| 712 | KLA213072S5 |
| 864 | KLA213672S5 |
| 1016 | KLA214272S5 |
| 1169 | KLA214872S5 |
| 1321 | KLA215472S5 |
| 1474 | KLA216072S5 |
| 1778 | KLA217272S5 |

610_{mm}
DEPTHS

| LENGTHS | CODE |
|---------|-------------|
| 610mm | KLU242472S4 |
| 765 | KLU243072S4 |
| 915 | KLU243672S4 |
| 1070 | KLU244272S4 |
| 1220 | KLU244872S4 |
| 1375 | KLU245472S4 |
| 1525 | KLU246072S4 |
| 1830 | KLU247272S4 |

| LENGTHS | CODE |
|---------|-------------|
| 559mm | KLA242472S4 |
| 712 | KLA243072S4 |
| 864 | KLA243672S4 |
| 1016 | KLA244272S4 |
| 1169 | KLA244872S4 |
| 1321 | KLA245472S4 |
| 1474 | KLA246072S4 |
| 1778 | KLA247272S4 |

610_{mm}
DEPTHS

| LENGTHS | CODE |
|---------|-------------|
| 610mm | KLU242472S5 |
| 765 | KLU243072S5 |
| 915 | KLU243672S5 |
| 1070 | KLU244272S5 |
| 1220 | KLU244872S5 |
| 1375 | KLU245472S5 |
| 1525 | KLU246072S5 |
| 1830 | KLU247272S5 |

| LENGTHS | CODE |
|---------|-------------|
| 559mm | KLA242472S5 |
| 712 | KLA243072S5 |
| 864 | KLA243672S5 |
| 1016 | KLA244272S5 |
| 1169 | KLA244872S5 |
| 1321 | KLA245472S5 |
| 1474 | KLA246072S5 |
| 1778 | KLA247272S5 |

Color: Speckled Gray

V4 4-SHELF VENTED UNITS

V5 5-SHELF VENTED UNITS

2140
mm
HEIGHT

Starter units include 2 factory assembled stationary post kits, stationary traverses, stationary traverse dovetails and shelf plates.
Add-On units include 1 factory assembled stationary post kit, stationary traverses, stationary traverse dovetails and shelf plates. Units ship complete in 2 boxes.

Starter



460_{mm}
DEPTHS

| LENGTHS | CODE |
|---------|-------------|
| 610mm | KLU182484V4 |
| 765 | KLU183084V4 |
| 915 | KLU183684V4 |
| 1070 | KLU184284V4 |
| 1220 | KLU184884V4 |
| 1375 | KLU185484V4 |
| 1525 | KLU186084V4 |
| 1830 | KLU187284V4 |

Add-on



| LENGTHS | CODE |
|---------|-------------|
| 559mm | KLA182484V4 |
| 712 | KLA183084V4 |
| 864 | KLA183684V4 |
| 1016 | KLA184284V4 |
| 1169 | KLA184884V4 |
| 1321 | KLA185484V4 |
| 1474 | KLA186084V4 |
| 1778 | KLA187284V4 |

Starter

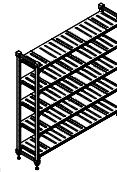

460_{mm}
DEPTHS

| LENGTHS | CODE |
|---------|-------------|
| 610mm | KLU182484V5 |
| 765 | KLU183084V5 |
| 915 | KLU183684V5 |
| 1070 | KLU184284V5 |
| 1220 | KLU184884V5 |
| 1375 | KLU185484V5 |
| 1525 | KLU186084V5 |
| 1830 | KLU187284V5 |

Add-on

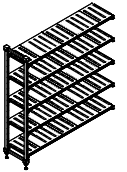

| LENGTHS | CODE |
|---------|-------------|
| 559mm | KLA182484V5 |
| 712 | KLA183084V5 |
| 864 | KLA183684V5 |
| 1016 | KLA184284V5 |
| 1169 | KLA184884V5 |
| 1321 | KLA185484V5 |
| 1474 | KLA186084V5 |
| 1778 | KLA187284V5 |

540_{mm}
DEPTHS

| LENGTHS | CODE |
|---------|-------------|
| 610mm | KLU212484V4 |
| 765 | KLU213084V4 |
| 915 | KLU213684V4 |
| 1070 | KLU214284V4 |
| 1220 | KLU214884V4 |
| 1375 | KLU215484V4 |
| 1525 | KLU216084V4 |
| 1830 | KLU217284V4 |

| LENGTHS | CODE |
|---------|-------------|
| 559mm | KLA212484V4 |
| 712 | KLA213084V4 |
| 864 | KLA213684V4 |
| 1016 | KLA214284V4 |
| 1169 | KLA214884V4 |
| 1321 | KLA215484V4 |
| 1474 | KLA216084V4 |
| 1778 | KLA217284V4 |

540_{mm}
DEPTHS

| LENGTHS | CODE |
|---------|-------------|
| 610mm | KLU212484V5 |
| 765 | KLU213084V5 |
| 915 | KLU213684V5 |
| 1070 | KLU214284V5 |
| 1220 | KLU214884V5 |
| 1375 | KLU215484V5 |
| 1525 | KLU216084V5 |
| 1830 | KLU217284V5 |

| LENGTHS | CODE |
|---------|-------------|
| 559mm | KLA212484V5 |
| 712 | KLA213084V5 |
| 864 | KLA213684V5 |
| 1016 | KLA214284V5 |
| 1169 | KLA214884V5 |
| 1321 | KLA215484V5 |
| 1474 | KLA216084V5 |
| 1778 | KLA217284V5 |

610_{mm}
DEPTHS

| LENGTHS | CODE |
|---------|-------------|
| 610mm | KLU242484V4 |
| 765 | KLU243084V4 |
| 915 | KLU243684V4 |
| 1070 | KLU244284V4 |
| 1220 | KLU244884V4 |
| 1375 | KLU245484V4 |
| 1525 | KLU246084V4 |
| 1830 | KLU247284V4 |

| LENGTHS | CODE |
|---------|-------------|
| 559mm | KLA242484V4 |
| 712 | KLA243084V4 |
| 864 | KLA243684V4 |
| 1016 | KLA244284V4 |
| 1169 | KLA244884V4 |
| 1321 | KLA245484V4 |
| 1474 | KLA246084V4 |
| 1778 | KLA247284V4 |

610_{mm}
DEPTHS

| LENGTHS | CODE |
|---------|-------------|
| 610mm | KLU242484V5 |
| 765 | KLU243084V5 |
| 915 | KLU243684V5 |
| 1070 | KLU244284V5 |
| 1220 | KLU244884V5 |
| 1375 | KLU245484V5 |
| 1525 | KLU246084V5 |
| 1830 | KLU247284V5 |

| LENGTHS | CODE |
|---------|-------------|
| 559mm | KLA242484V5 |
| 712 | KLA243084V5 |
| 864 | KLA243684V5 |
| 1016 | KLA244284V5 |
| 1169 | KLA244884V5 |
| 1321 | KLA245484V5 |
| 1474 | KLA246084V5 |
| 1778 | KLA247284V5 |

Color: Speckled Gray

S4

S5

4-SHELF SOLID UNITS

5-SHELF SOLID UNITS

2140

mm
HEIGHT

Starter units include 2 factory assembled stationary post kits, stationary traverses, stationary traverse dovetails and shelf plates.

Add-On units include 1 factory assembled stationary post kit, stationary traverses, stationary traverse dovetails and shelf plates. Units ship complete in 2 boxes.

Starter



460mm
DEPTHS

| LENGTHS | CODE |
|---------|-------------|
| 610mm | KLU182484S4 |
| 765 | KLU183084S4 |
| 915 | KLU183684S4 |
| 1070 | KLU184284S4 |
| 1220 | KLU184884S4 |
| 1375 | KLU185484S4 |
| 1525 | KLU186084S4 |
| 1830 | KLU187284S4 |

Add-on



| LENGTHS | CODE |
|---------|-------------|
| 559mm | KLA182484S4 |
| 712 | KLA183084S4 |
| 864 | KLA183684S4 |
| 1016 | KLA184284S4 |
| 1169 | KLA184884S4 |
| 1321 | KLA185484S4 |
| 1474 | KLA186084S4 |
| 1778 | KLA187284S4 |

Starter



460mm
DEPTHS

| LENGTHS | CODE |
|---------|-------------|
| 610mm | KLU182484S5 |
| 765 | KLU183084S5 |
| 915 | KLU183684S5 |
| 1070 | KLU184284S5 |
| 1220 | KLU184884S5 |
| 1375 | KLU185484S5 |
| 1525 | KLU186084S5 |
| 1830 | KLU187284S5 |

Add-on



| LENGTHS | CODE |
|---------|-------------|
| 559mm | KLA182484S5 |
| 712 | KLA183084S5 |
| 864 | KLA183684S5 |
| 1016 | KLA184284S5 |
| 1169 | KLA184884S5 |
| 1321 | KLA185484S5 |
| 1474 | KLA186084S5 |
| 1778 | KLA187284S5 |

540mm
DEPTHS

| LENGTHS | CODE |
|---------|-------------|
| 610mm | KLU212484S4 |
| 765 | KLU213084S4 |
| 915 | KLU213684S4 |
| 1070 | KLU214284S4 |
| 1220 | KLU214884S4 |
| 1375 | KLU215484S4 |
| 1525 | KLU216084S4 |
| 1830 | KLU217284S4 |

| LENGTHS | CODE |
|---------|-------------|
| 559mm | KLA212484S4 |
| 712 | KLA213084S4 |
| 864 | KLA213684S4 |
| 1016 | KLA214284S4 |
| 1169 | KLA214884S4 |
| 1321 | KLA215484S4 |
| 1474 | KLA216084S4 |
| 1778 | KLA217284S4 |

540mm
DEPTHS

| LENGTHS | CODE |
|---------|-------------|
| 610mm | KLU212484S5 |
| 765 | KLU213084S5 |
| 915 | KLU213684S5 |
| 1070 | KLU214284S5 |
| 1220 | KLU214884S5 |
| 1375 | KLU215484S5 |
| 1525 | KLU216084S5 |
| 1830 | KLU217284S5 |

| LENGTHS | CODE |
|---------|-------------|
| 559mm | KLA212484S5 |
| 712 | KLA213084S5 |
| 864 | KLA213684S5 |
| 1016 | KLA214284S5 |
| 1169 | KLA214884S5 |
| 1321 | KLA215484S5 |
| 1474 | KLA216084S5 |
| 1778 | KLA217284S5 |

610mm
DEPTHS

| LENGTHS | CODE |
|---------|-------------|
| 610mm | KLU242484S4 |
| 765 | KLU243084S4 |
| 915 | KLU243684S4 |
| 1070 | KLU244284S4 |
| 1220 | KLU244884S4 |
| 1375 | KLU245484S4 |
| 1525 | KLU246084S4 |
| 1830 | KLU247284S4 |

| LENGTHS | CODE |
|---------|-------------|
| 559mm | KLA242484S4 |
| 712 | KLA243084S4 |
| 864 | KLA243684S4 |
| 1016 | KLA244284S4 |
| 1169 | KLA244884S4 |
| 1321 | KLA245484S4 |
| 1474 | KLA246084S4 |
| 1778 | KLA247284S4 |

610mm
DEPTHS

| LENGTHS | CODE |
|---------|-------------|
| 610mm | KLU242484S5 |
| 765 | KLU243084S5 |
| 915 | KLU243684S5 |
| 1070 | KLU244284S5 |
| 1220 | KLU244884S5 |
| 1375 | KLU245484S5 |
| 1525 | KLU246084S5 |
| 1830 | KLU247284S5 |

| LENGTHS | CODE |
|---------|-------------|
| 559mm | KLA242484S5 |
| 712 | KLA243084S5 |
| 864 | KLA243684S5 |
| 1016 | KLA244284S5 |
| 1169 | KLA244884S5 |
| 1321 | KLA245484S5 |
| 1474 | KLA246084S5 |
| 1778 | KLA247284S5 |

Color: Speckled Gray

V4

4-SHELF VENTED MOBILE UNITS

V5

5-SHELF VENTED MOBILE UNITS

Mobile units include 2 factory assembled mobile post kits, 8 stationary traverses, stationary traverse dovetails, shelf plates and 4 premium swivel casters with total locking brake. Units ship complete in 2 boxes.

1784
mm

HEIGHT include 7" Casters



460_{mm}
DEPTHS

| CODE | DIMENSIONS DxLxH |
|--------------|---------------------|
| KLMU183670V4 | 460x915x1784mm |
| KLMU184270V4 | 460x1070x1784 |
| KLMU184870V4 | 460x1220x1784 |
| KLMU185470V4 | 460x1375x1784 |
| KLMU186070V4 | 460x1525x1784 |
| KLMU187270V4 | 460x1830x1784 |

540_{mm}
DEPTHS

| | |
|--------------|----------------|
| KLMU213670V4 | 540x915x1784mm |
| KLMU214270V4 | 540x1070x1784 |
| KLMU214870V4 | 540x1220x1784 |
| KLMU215470V4 | 540x1375x1784 |
| KLMU216070V4 | 540x1525x1784 |
| KLMU217270V4 | 540x1830x1784 |

610_{mm}
DEPTHS

| | |
|--------------|----------------|
| KLMU243670V4 | 610x915x1784mm |
| KLMU244270V4 | 610x1070x1784 |
| KLMU244870V4 | 610x1220x1784 |
| KLMU245470V4 | 610x1375x1784 |
| KLMU246070V4 | 610x1525x1784 |
| KLMU247270V4 | 610x1830x1784 |

1987
mm

HEIGHT include 7" Casters

460_{mm}
DEPTHS

| CODE | DIMENSIONS DxLxH |
|--------------|---------------------|
| KLMU183678V4 | 460x915x1987mm |
| KLMU184278V4 | 460x1070x1987 |
| KLMU184878V4 | 460x1220x1987 |
| KLMU185478V4 | 460x1375x1987 |
| KLMU186078V4 | 460x1525x1987 |
| KLMU187278V4 | 460x1830x1987 |

540_{mm}
DEPTHS

| | |
|--------------|----------------|
| KLMU213678V4 | 540x915x1987mm |
| KLMU214278V4 | 540x1070x1987 |
| KLMU214878V4 | 540x1220x1987 |
| KLMU215478V4 | 540x1375x1987 |
| KLMU216078V4 | 540x1525x1987 |
| KLMU217278V4 | 540x1830x1987 |

610_{mm}
DEPTHS

| | |
|--------------|----------------|
| KLMU243678V4 | 610x915x1987mm |
| KLMU244278V4 | 610x1070x1987 |
| KLMU244878V4 | 610x1220x1987 |
| KLMU245478V4 | 610x1375x1987 |
| KLMU246078V4 | 610x1525x1987 |
| KLMU247278V4 | 610x1830x1987 |

Color: Speckled Gray



460_{mm}
DEPTHS

| CODE | DIMENSIONS DxLxH |
|--------------|---------------------|
| KLMU183670V5 | 460x915x1784mm |
| KLMU184270V5 | 460x1070x1784 |
| KLMU184870V5 | 460x1220x1784 |
| KLMU185470V5 | 460x1375x1784 |
| KLMU186070V5 | 460x1525x1784 |
| KLMU187270V5 | 460x1830x1784 |

540_{mm}
DEPTHS

| | |
|--------------|----------------|
| KLMU213670V5 | 540x915x1784mm |
| KLMU214270V5 | 540x1070x1784 |
| KLMU214870V5 | 540x1220x1784 |
| KLMU215470V5 | 540x1375x1784 |
| KLMU216070V5 | 540x1525x1784 |
| KLMU217270V5 | 540x1830x1784 |

610_{mm}
DEPTHS

| | |
|--------------|----------------|
| KLMU243670V5 | 610x915x1784mm |
| KLMU244270V5 | 610x1070x1784 |
| KLMU244870V5 | 610x1220x1784 |
| KLMU245470V5 | 610x1375x1784 |
| KLMU246070V5 | 610x1525x1784 |
| KLMU247270V5 | 610x1830x1784 |

460_{mm}
DEPTHS

| CODE | DIMENSIONS DxLxH |
|--------------|---------------------|
| KLMU183678V5 | 460x915x1987mm |
| KLMU184278V5 | 460x1070x1987 |
| KLMU184878V5 | 460x1220x1987 |
| KLMU185478V5 | 460x1375x1987 |
| KLMU186078V5 | 460x1525x1987 |
| KLMU187278V5 | 460x1830x1987 |

540_{mm}
DEPTHS

| | |
|--------------|----------------|
| KLMU213678V5 | 540x915x1987mm |
| KLMU214278V5 | 540x1070x1987 |
| KLMU214878V5 | 540x1220x1987 |
| KLMU215478V5 | 540x1375x1987 |
| KLMU216078V5 | 540x1525x1987 |
| KLMU217278V5 | 540x1830x1987 |

610_{mm}
DEPTHS

| | |
|--------------|----------------|
| KLMU243678V5 | 610x915x1987mm |
| KLMU244278V5 | 610x1070x1987 |
| KLMU244878V5 | 610x1220x1987 |
| KLMU245478V5 | 610x1375x1987 |
| KLMU246078V5 | 610x1525x1987 |
| KLMU247278V5 | 610x1830x1987 |

S4

4-SHELF SOLID MOBILE UNITS

S5

5-SHELF SOLID MOBILE UNITS

Mobile units include 2 factory assembled mobile post kits, 8 stationary traverses, stationary traverse dovetails, shelf plates and 4 premium swivel casters with total locking brake. Units ship complete in 2 boxes.

1784
mm
HEIGHT

include 7" Casters



460_{mm}
DEPTHS

| CODE | DIMENSIONS DxLxH |
|--------------|---------------------|
| KLMU183670S4 | 460x915x1784mm |
| KLMU184270S4 | 460x1070x1784 |
| KLMU184870S4 | 460x1220x1784 |
| KLMU185470S4 | 460x1375x1784 |
| KLMU186070S4 | 460x1525x1784 |
| KLMU187270S4 | 460x1830x1784 |

540_{mm}
DEPTHS

| | |
|--------------|----------------|
| KLMU213670S4 | 540x915x1784mm |
| KLMU214270S4 | 540x1070x1784 |
| KLMU214870S4 | 540x1220x1784 |
| KLMU215470S4 | 540x1375x1784 |
| KLMU216070S4 | 540x1525x1784 |
| KLMU217270S4 | 540x1830x1784 |

610_{mm}
DEPTHS

| | |
|--------------|----------------|
| KLMU243670S4 | 610x915x1784mm |
| KLMU244270S4 | 610x1070x1784 |
| KLMU244870S4 | 610x1220x1784 |
| KLMU245470S4 | 610x1375x1784 |
| KLMU246070S4 | 610x1525x1784 |
| KLMU247270S4 | 610x1830x1784 |

1987
mm
HEIGHT

include 7" Casters

460_{mm}
DEPTHS

| CODE | DIMENSIONS DxLxH |
|--------------|---------------------|
| KLMU183678S4 | 460x915x1987mm |
| KLMU184278S4 | 460x1070x1987 |
| KLMU184878S4 | 460x1220x1987 |
| KLMU185478S4 | 460x1375x1987 |
| KLMU186078S4 | 460x1525x1987 |
| KLMU187278S4 | 460x1830x1987 |

540_{mm}
DEPTHS

| | |
|--------------|----------------|
| KLMU213678S4 | 540x915x1987mm |
| KLMU214278S4 | 540x1070x1987 |
| KLMU214878S4 | 540x1220x1987 |
| KLMU215478S4 | 540x1375x1987 |
| KLMU216078S4 | 540x1525x1987 |
| KLMU217278S4 | 540x1830x1987 |

610_{mm}
DEPTHS

| | |
|--------------|----------------|
| KLMU243678S4 | 610x915x1987mm |
| KLMU244278S4 | 610x1070x1987 |
| KLMU244878S4 | 610x1220x1987 |
| KLMU245478S4 | 610x1375x1987 |
| KLMU246078S4 | 610x1525x1987 |
| KLMU247278S4 | 610x1830x1987 |

Color: Speckled Gray



460_{mm}
DEPTHS

| CODE | DIMENSIONS DxLxH |
|--------------|---------------------|
| KLMU183670S5 | 460x915x1784mm |
| KLMU184270S5 | 460x1070x1784 |
| KLMU184870S5 | 460x1220x1784 |
| KLMU185470S5 | 460x1375x1784 |
| KLMU186070S5 | 460x1525x1784 |
| KLMU187270S5 | 460x1830x1784 |

540_{mm}
DEPTHS

| | |
|--------------|----------------|
| KLMU213670S5 | 540x915x1784mm |
| KLMU214270S5 | 540x1070x1784 |
| KLMU214870S5 | 540x1220x1784 |
| KLMU215470S5 | 540x1375x1784 |
| KLMU216070S5 | 540x1525x1784 |
| KLMU217270S5 | 540x1830x1784 |

610_{mm}
DEPTHS

| | |
|--------------|----------------|
| KLMU243670S5 | 610x915x1784mm |
| KLMU244270S5 | 610x1070x1784 |
| KLMU244870S5 | 610x1220x1784 |
| KLMU245470S5 | 610x1375x1784 |
| KLMU246070S5 | 610x1525x1784 |
| KLMU247270S5 | 610x1830x1784 |

460_{mm}
DEPTHS

| CODE | DIMENSIONS DxLxH |
|--------------|---------------------|
| KLMU183678S5 | 460x915x1987mm |
| KLMU184278S5 | 460x1070x1987 |
| KLMU184878S5 | 460x1220x1987 |
| KLMU185478S5 | 460x1375x1987 |
| KLMU186078S5 | 460x1525x1987 |
| KLMU187278S5 | 460x1830x1987 |

540_{mm}
DEPTHS

| | |
|--------------|----------------|
| KLMU213678S5 | 540x915x1987mm |
| KLMU214278S5 | 540x1070x1987 |
| KLMU214878S5 | 540x1220x1987 |
| KLMU215478S5 | 540x1375x1987 |
| KLMU216078S5 | 540x1525x1987 |
| KLMU217278S5 | 540x1830x1987 |

610_{mm}
DEPTHS

| | |
|--------------|----------------|
| KLMU243678S5 | 610x915x1987mm |
| KLMU244278S5 | 610x1070x1987 |
| KLMU244878S5 | 610x1220x1987 |
| KLMU245478S5 | 610x1375x1987 |
| KLMU246078S5 | 610x1525x1987 |
| KLMU247278S5 | 610x1830x1987 |

K-LarderPro

2-SHELF VENTED UNDERCOUNTER UNITS

- Create storage in underutilized or hard-to-reach undercounter areas.
- Ideal for storing condiments, to-go containers, and paper disposables.
- Units ship complete in 1 box, post kits are pre-assembled.

| CODE | DIMENSIONS DxLxH |
|-----------------|---------------------|
| Stationary Unit | |
| KLU183630V2 | 460 x 915 x 765 mm |
| KLU184830V2 | 460 x 1220 x 765 |

Color: Speckled Gray

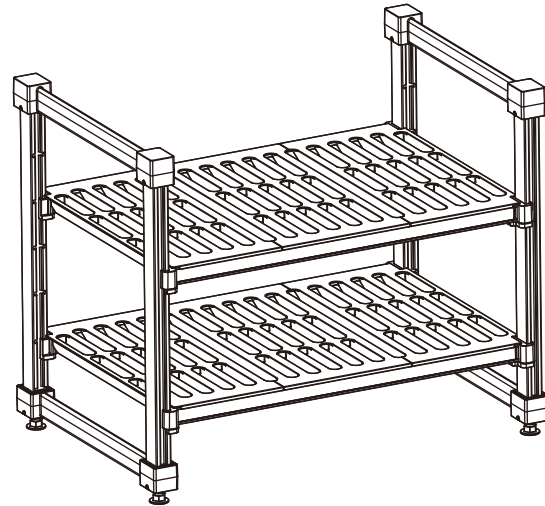

2-SHELF SOLID UNDERCOUNTER UNITS

| CODE | DIMENSIONS DxLxH |
|-----------------|---------------------|
| Stationary Unit | |
| KLU183630S2 | 460 x 915 x 765 mm |
| KLU184830S2 | 460 x 1220 x 765 |

Color: Speckled Gray

VENTED SHELF PLATE

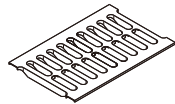

fit all the shelves size.

460 mm
DEPTHS

| CODE | DIMENSIONS LxWxH |
|-----------|---------------------|
| KLA-V1706 | L430xW151xH31 mm |
| KLA-V1711 | L430xW275xH31 |
| KLA-V1712 | L430xW303xH31 |
| KLA-V1718 | L430xW455xH31 |

540 mm
DEPTHS

| | |
|-----------|------------------|
| KLA-V2006 | L510xW151xH31 mm |
| KLA-V2011 | L510xW275xH31 |
| KLA-V2012 | L510xW303xH31 |
| KLA-V2018 | L510xW454xH31 |

610 mm
DEPTHS

| | |
|-----------|------------------|
| KLA-V2306 | L580xW151xH31 mm |
| KLA-V2311 | L580xW275xH31 |
| KLA-V2312 | L580xW303xH31 |
| KLA-V2318 | L580xW455xH31 |

Color: Speckled Gray

SOLID SHELF PLATE

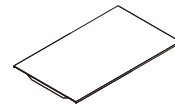

460 mm
DEPTHS

| CODE | DIMENSIONS LxWxH |
|-----------|---------------------|
| KLA-S1706 | L430xW151xH31 mm |
| KLA-S1711 | L430xW275xH31 |
| KLA-S1712 | L430xW303xH31 |
| KLA-S1718 | L430xW455xH31 |

540 mm
DEPTHS

| | |
|-----------|------------------|
| KLA-S2006 | L510xW151xH31 mm |
| KLA-S2011 | L510xW275xH31 |
| KLA-S2012 | L510xW303xH31 |
| KLA-S2018 | L510xW454xH31 |

610 mm
DEPTHS

| | |
|-----------|------------------|
| KLA-S2306 | L580xW151xH31 mm |
| KLA-S2311 | L580xW275xH31 |
| KLA-S2312 | L580xW303xH31 |
| KLA-S2318 | L580xW455xH31 |

Top Post connector

Bottom Post connector

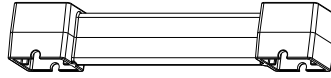

| | CODE | DIMENSIONS LxWxH |
|------------------------------------|----------|---------------------|
| 460 _{mm} DEPTHS | KLA-A18U | L460xW56xH62 mm |
| 540 _{mm} DEPTHS | KLA-A21U | L540xW56xH62 mm |
| 610 _{mm} DEPTHS | KLA-A24U | L610xW56xH62 mm |

| | CODE | DIMENSIONS LxWxH |
|------------------------------------|----------|---------------------|
| 460 _{mm} DEPTHS | KLA-A18D | L460xW56xH55 mm |
| 540 _{mm} DEPTHS | KLA-A21D | L540xW56xH55 mm |
| 610 _{mm} DEPTHS | KLA-A24D | L610xW56xH55 mm |

Color: Speckled Gray

POST(UNDERCOUNTER、STATIONARY、ADD-ON)



| | CODE | DIMENSIONS LxWxH |
|-------------------------------------|---------|----------------------|
| 765 _{mm} HEIGHT | KLA-C28 | L46.8*W34.8*H727 mm |
| 1630 _{mm} HEIGHT | KLA-C64 | L46.8*W34.8*H1592 mm |
| 1830 _{mm} HEIGHT | KLA-C72 | L46.8*W34.8*H1792 mm |
| 2140 _{mm} HEIGHT | KLA-C84 | L46.8*W34.8*H2107 mm |

POST-MOBILE

| | | |
|-------------------------------------|---------|----------------------|
| 1784 _{mm} HEIGHT | KLA-C64 | L46.8*W34.8*H1592 mm |
| 1987 _{mm} HEIGHT | KLA-C72 | L46.8*W34.8*H1792 mm |

Traverse

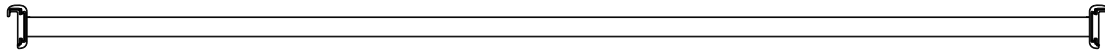

| LENGTHS | CODE | DIMENSIONS LxWxH |
|---------|---------|---------------------|
| 610mm | KLA-B24 | L505xW32xH38.5mm |
| 765 | KLA-B30 | L655*W32xH38.5 |
| 915 | KLA-B36 | L810xW32xH38.5 |
| 1070 | KLA-B42 | L960xW32xH38.5 |
| 1220 | KLA-B48 | L1110xW32xH38.5 |
| 1375 | KLA-B54 | L1265xW32xH38.5 |
| 1525 | KLA-B60 | L1415xW32xH38.5 |
| 1830 | KLA-B72 | L1720xW32xH38.5 |

Stationary Traverse Dovetails (MARK "L")
Stationary Traverse Dovetails (MARK "R")

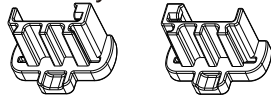

| CODE | DIMENSIONS LxWxH |
|---------|---------------------|
| KLA-C5L | L65xW48xH40 mm |
| KLA-C5R | L65xW48xH40 mm |

Threaded Post Insert-L
Threaded Post Insert-R

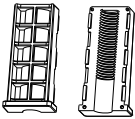

| CODE | DIMENSIONS LxWxH |
|---------|---------------------|
| KLA-C2L | L72xW33xH16.9 mm |
| KLA-C2R | L72xW33xH16.9 mm |

Move t Stationary Traverse Corner connectors into place

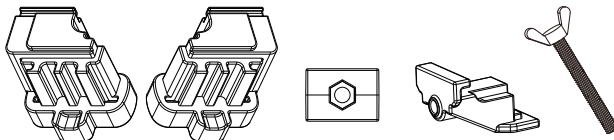

| CODE | DIMENSIONS LxWxH |
|---------|---------------------|
| KLA-B2L | L66xW56xH74 mm |
| KLA-B2R | L66xW56xH74 mm |
| KLA-B3 | L30xW22xH14 mm |
| KLA-B4 | L47xW35xH30 mm |

Post Connector Wedge (MARK "L")
Post Connector Wedge (MARK "R")

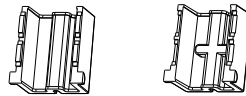

| CODE | DIMENSIONS LxWxH |
|---------|---------------------|
| KLA-A1F | L55xW54xH28 mm |
| KLA-A1B | L55xW54xH28 mm |

Adjustable feet



| CODE | DIMENSIONS LxWxH |
|--------|---------------------|
| KLA-C1 | L40xW40xH92.5 mm |

5" Braked Casters

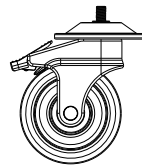

| CODE | DIMENSIONS LxWxH |
|---------|---------------------|
| KLA-C28 | L46.8*W34.8*H727 mm |

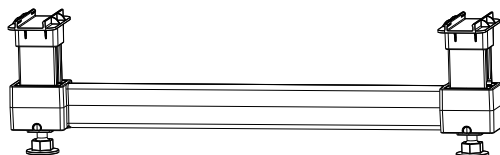

| CODE | DIMENSIONS WxH |
|---------|-------------------|
| KLD18H6 | 460*165mm |
| KLD21H6 | 540*165mm |
| KLD24H6 | 610*165mm |

Material: Plastic



Preparation



SHELVING SERIES



DOUGH BOXES



SPINNER



CONDIMENT SET



PE CUTTING BOARD

SHELVING SERIES

Improve transportation efficiency.

Fast Transfer: Quickly move ingredients, seasonings, or semi-finished products between areas such as the kitchen, warehouse, and front hall to reduce the need for manual transportation multiple times.

Batch processing: Multi-level designs or large-capacity vehicles can transport large quantities of raw materials (such as vegetables, frozen goods, and seasonings) at once, saving time and labor.

Ensuring the hygiene and safety of food ingredients.

Categorical segregation: Use layered and compartmentalized designs (e.g., separate areas for raw and cooked foods, containers with lids) to prevent cross-contamination.

Temporary Storage: Store raw materials temporarily during peak meal preparation periods to prevent direct exposure to work surfaces or the ground.

- The top features a specialized design that allows for the placement of a cutting board, thereby streamlining the process of preparing food.



- never rust or corrode protection, durability, smooth surface that is easier to clean.



- (Gray areas) Made of Polypropylene, featuring rust and corrosion resistance, durability; smooth surface for cleaning easier.

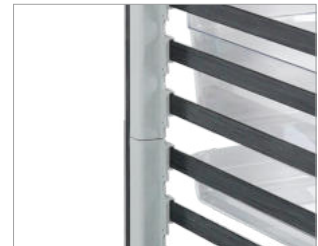

- Available in various sizes, can be paired with food pans, trays, and dough boxes for use. Multi-layer design to maximize space efficiency.

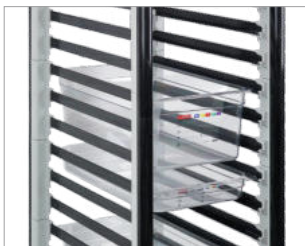

- Plastic casters never rust or corrode, Quiet.



SHELVING SERIES (9-tier)



KDV11-9

GN11-9

GN11X2-9

GN12-9

KFV2230-9

| CODE | DIMENSIONS | CASE PACK | G.W. | Carton DIM. | MATERIALS | HOLDING CAPACITY | TIER QTY |
|-----------|-------------------|-----------|----------|----------------|-----------|------------------------------|----------|
| KDV11-9 | L700xW495xH1035mm | 1PCS | 15.48kgs | 85.5x58.5x23cm | PP+EP | 530x320mm Tray/Tier | 9 tier |
| GN11-9 | L700xW495xH1035mm | 1PCS | 15.48kgs | 66x15x91cm | PP+EP | 1*1/1 or 2*1/2 food pan/tier | 9 tier |
| GN11X2-9 | L880xW695xH1035mm | 1PCS | 24.24kgs | 66x29.5x85cm | PP+EP | 1*1/1 or 2*1/2 food pan/tier | 9 tier |
| GN12-9 | L770xW650xH1035mm | 1PCS | 17.23kgs | 68.5x22.5x79cm | PP+EP | 1*1/1 or 2*1/2 food pan/tier | 9 tier |
| KFV2230-9 | L730xW520xH1035mm | 1PCS | 16.63kgs | 66.5x15.5x87cm | PP+EP | 1*600*400 Dough Boxes/tier | 9 tier |

Weight Bearing 170KG

SHELVING SERIES (18-tier)



KDV11-18

GN11-18

GN11X2-18

GN12-18

KFV2230-18

| CODE | DIMENSIONS | CASE PACK | G.W. | Carton DIM. | MATERIALS | HOLDING CAPACITY | TIER QTY |
|------------|-------------------|-----------|----------|-------------------|-----------|------------------------------|----------|
| KDV11-18 | L700xW495xH1760mm | 1PCS | 24.82kgs | 160.5x61x17cm | PP+EP | 530x320mm Tray/Tier | 18 tier |
| GN11-18 | L700xW495xH1760mm | 1PCS | 24.82kgs | 160x60.5x14.5cm | PP+EP | 1*1/1 or 2*1/2 food pan/tier | 18 tier |
| GN11X2-18 | L880xW695xH1760mm | 1PCS | 40.22kgs | 160.5x68.5x19.5cm | PP+EP | 1*1/1 or 2*1/2 food pan/tier | 18 tier |
| GN12-18 | L770xW650xH1760mm | 1PCS | 27.72kgs | 160.5x68.5x19.5cm | PP+EP | 1*1/1 or 2*1/2 food pan/tier | 18 tier |
| KFV2230-18 | L730xW520xH1760mm | 1PCS | 26.54kgs | 160.5x65.5x13cm | PP+EP | 1*600*400 Dough Boxes/tier | 18 tier |

Weight Bearing 340KG

DOUGH BOXES



- Ideal for storing, transporting, proofing and cooling dough.
- Lightweight, durable, and break resistant.
- Chemical resistant material won't absorb odors and is easy to clean.



- Boxes nest tightly together to keep out dirt and contaminants, extending product freshness.
- Each box acts as a tight lid for the box below, reducing the need and expense of covers.
- Cover can be used as tray.

- Boxes won't bend or lose their shape.



DOUGH BOXES



| | | | |
|-------------|-----------------|-----------------|------------------|
| CODE: | DB4532-1 | DB4532-2 | DB4532-3 |
| MATERIALS: | PP | PP | PP |
| DIMENSIONS: | L450xW320xH45mm | L450xW320xH87mm | L450xW320xH159mm |
| CASE PACK: | 18pcs | 6pcs | 6pcs |



| | | | |
|-------------|-----------------|------------------|------------------|
| CODE: | DB5638-1 | DB5638-2 | DB5638-3 |
| MATERIALS: | PP | PP | PP |
| DIMENSIONS: | L565xW385xH70mm | L565xW385xH102mm | L565xW385xH126mm |
| CASE PACK: | 6pcs | 6pcs | 6pcs |



| | | | |
|-------------|----------------------------|----------------------------|------------------|
| CODE: | DB5638-A | DB5638-A | RT02 |
| MATERIALS: | L580xW395xH30mm | L580xW395xH30mm | L647*W449xH165mm |
| DIMENSIONS: | | | 61x41x1.9cm |
| CASE PACK: | 24pcs | 24pcs | 1pcs |
| FIT: | DB5638-1 DB5638-2 DB5638-3 | DB5638-1 DB5638-2 DB5638-3 | |

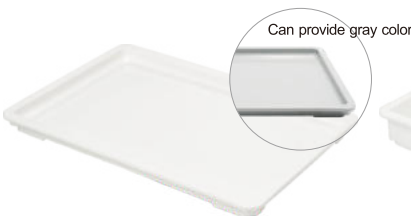

| | | | |
|-------------|-----------------|-----------------|------------------|
| CODE: | DB6545-1 | DB6545-2 | DB6545-3 |
| MATERIALS: | PP | PP | PP |
| DIMENSIONS: | L650xW455xH45mm | L650xW455xH85mm | L650xW455xH163mm |
| CASE PACK: | 12pcs | 6pcs | 4pcs |

DOUGH BOXES



Each box acts as a tight lid for the box below, reducing the need and expense of covers.



The label is wipeable and repetition

| | | | |
|-----------------------------|-----------------|-----------------|------------------|
| | | | |
| CODE: KFA5332 | KF5332-9 | KFA4030 | KF4030-10 |
| MATERIALS: PE | PP | PE | PP |
| DIMENSIONS: L530xW325xH16mm | L530xW325xH92mm | L411xW310xH21mm | L398xW297xH101mm |
| CAPACITY: \ | 18L | \ | 12L |
| CASE PACK: 24pcs | 6pcs | 30pcs | 6pcs |

| | | |
|-------------------------------|-----------------|------------------|
| | | |
| CODE: KFA6040 | KF6040-7 | KF6040-10 |
| MATERIALS: PP | PP | PP |
| DIMENSIONS: L605xW408xH18.8mm | L600xW400xH70mm | L600xW400xH100mm |
| CAPACITY: \ | 11.4L | 17.5L |
| CASE PACK: 18pcs | 6pcs | 6pcs |



SPINNER

- Ideal for draining fruits and vegetables.
- Enhances food quality and freshness.
- Easy to clean.



| | |
|---------------|----------------|
| CODE: | KO4352A |
| MATERIALS: | PP |
| DIMENSIONS: | Φ43xH52cm |
| CAPACITY: | 19L |
| CASE PACK: | 1pcs |
| GROSS WEIGHT: | 4.84kgs |
| CARTON SIZE: | 43x43x54cm |



| | |
|---------------|----------------|
| CODE: | KO3344A |
| MATERIALS: | PP |
| DIMENSIONS: | ∅33xH44cm |
| CAPACITY: | 9.5L |
| CASE PACK: | 1pcs |
| GROSS WEIGHT: | 3.29kgs |
| CARTON SIZE: | 33x33x46cm |



CONDIMENT SET

- A staple in the kitchen, at the condiment station or on the dining table.
- Clear shatter-resistant View and color coded.
- lids make it easy to identify contents.
- Dishwasher safe.

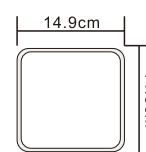
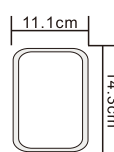
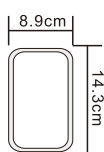
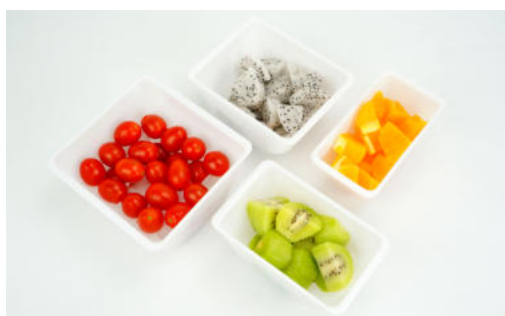

| CODE: | KSF6 | KSF5 | KSF4 | KSF3 |
|-------------|--------------------|--------------------|--------------------|--------------------|
| DIMENSIONS: | L493xW155.5xH100mm | L493xW155.5xH100mm | L493xW155.5xH100mm | L493xW155.5xH100mm |
| CAPACITY: | 6x412ml | 5x500ml | 4x624ml | 3x902ml |
| CASE PACK: | 12pcs | 12pcs | 12pcs | 12pcs |

PE CUTTING BOARD SERIES

- Food-grade PE, meets food contact safety standards, Safe for all ingredients
- High density & toughness durable, no marks/cracks, Strong toughness, suitable for chopping & cutting
- Oil & water proof, easy to clean, anti-bacterial, can be cleaned by hand or in a dishwasher
- Color-coded, different colors for different foods Stop cross-contamination



20mm :

all the colors except black and nature.



| | | | |
|-------------|-----------------|-----------------|-----------------|
| CODE: | KBE3525-20W | KBE4530-20W | KBE6040-20W |
| DIMENSIONS: | L350xW248xH20mm | L448xW299xH20mm | L599xW398xH20mm |
| CASE PACK: | 6pcs | 4pcs | 3pcs |

13~15mm :



| | | | | |
|-------------|-----------------|-------------------|-----------------|-----------------|
| CODE: | KBU1016-13W | KBU1218-13W | KBU1520-13W | KBU1824-13W |
| DIMENSIONS: | L400xW250xH13mm | L505xW383xH12.5mm | L452xW301xH13mm | L603xW453xH13mm |
| CASE PACK: | 6pcs | 6pcs | 6pcs | 4pcs |

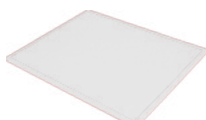

| | | |
|-------------|-----------------|-----------------|
| CODE: | KBGN11-15W | KBGN12-15W |
| DIMENSIONS: | L535xW334xH15mm | L650xW534xH15mm |
| CASE PACK: | 4pcs | 3pcs |



Delivery



COVER



GN PLATE



K-SERIES



BUFFET BARS



NON-SLIP TRAYS



COVER

Crystal clear, unbreakable.
For use with wooden frames and melamine bases.

KM11-PC1
↓
PMMA
(Available in PMMA as an option)

1/1

1/2

2/3



Black handle

| | | | |
|-------------|------------------|------------------|------------------|
| CODE: | KM11-PC1 | KM21-PC1 | KM32-PC1 |
| DIMENSIONS: | L542xD337xH207mm | L337xD278xH175mm | L368xD337xH191mm |
| CASE PACK: | 12pcs | 24pcs | 12pcs |



Black handle

| | | | |
|-------------|------------------|------------------|------------------|
| CODE: | KM11-PC1A | KM21-PC1A | KM32-PC1A |
| DIMENSIONS: | L542xD337xH207mm | L337xD278xH175mm | L368xD337xH191mm |
| CASE PACK: | 12pcs | 24pcs | 12pcs |



Chrome handle

| | | | |
|-------------|------------------|------------------|------------------|
| CODE: | KM11-PC2 | KM21-PC2 | KM32-PC2 |
| DIMENSIONS: | L542xD337xH207mm | L337xD278xH175mm | L368xD337xH191mm |
| CASE PACK: | 12pcs | 24pcs | 12pcs |



Chrome handle

| | | | |
|-------------|------------------|------------------|------------------|
| CODE: | KM11-PC2A | KM21-PC2A | KM32-PC2A |
| DIMENSIONS: | L542xD337xH207mm | L337xD278xH175mm | L368xD337xH191mm |
| CASE PACK: | 12pcs | 24pcs | 12pcs |



| | | | |
|-------------|------------------|------------------|------------------|
| CODE: | KM11-PCD | KM21-PCD | KM32-PCD |
| DIMENSIONS: | L552xW337xH190mm | L340xW297xH162mm | L373xW355xH191mm |
| CASE PACK: | 6pcs | 6pcs | 4pcs |



GN LID with handle



| | | | | |
|-------------|-----------------|-----------------|-----------------|-------------------|
| CODE: | KM11-PC | KM21-PC | KM31-PC | KM42-PC |
| DIMENSIONS: | L535xW330xH96mm | L330xW270xH96mm | L330xW181xH98mm | L535xW167.5xH97mm |
| CASE PACK: | 12pcs | 24pcs | 36pcs | 36pcs |

GN COVER AND BASE



| | | | |
|-------------|------------------|---------------------|-----------------|
| CODE: | KM11-PCD | GN11-29W | KM11-T |
| DIMENSIONS: | L552xW337xH190mm | L528.5xW323.5xH29mm | L555xW350xH77mm |
| CASE PACK: | 6pcs | 8pcs | 6pcs |



| | | | |
|-------------|------------------|-------------------|-----------------|
| CODE: | KM21-PCD | GN21-29W | KM21-T |
| DIMENSIONS: | L340xW297xH162mm | L323.5xW264xH29mm | L350xW290xH77mm |
| CASE PACK: | 6pcs | 20pcs | 12pcs |



| | | | |
|-------------|------------------|-----------------|-----------------|
| CODE: | KM32-PCD | GN32-29W | KM32-T |
| DIMENSIONS: | L373xW355xH191mm | L350xW323xH29mm | L375xW346xH77mm |
| CASE PACK: | 4pcs | 18pcs | 6pcs |

GN Plate (Melamine)



H:20 mm

H:29 mm

H:40 mm

H:65 mm

H:100 mm

1/1



| | | | | |
|-------------|-----------------|---------------------|---------------------|-----------------|
| CODE: | GN11-20W | GN11-29W | GN11-40W | GN11-65W |
| DIMENSIONS: | L530xW325xH20mm | L528.5xW323.5xH29mm | L525.8xW323.5xH40mm | L520xW318xH65mm |
| CASE PACK: | 10pcs | 8pcs | 6pcs | 4pcs |

1/2



| | | | | | |
|-------------|-----------------|-------------------|---------------------|---------------------|------------------|
| CODE: | GN21-20W | GN21-29W | GN21-40W | GN21-65W | GN21-100W |
| DIMENSIONS: | L325xW265xH20mm | L323.5xW264xH29mm | L321.7xW260.8xH40mm | L321.7xW260.8xH65mm | L325xW265xH100mm |
| CASE PACK: | 18pcs | 20pcs | 18pcs | 10pcs | 6pcs |

1/3



| | | | | |
|-------------|-----------------|-------------------|-----------------|------------------|
| CODE: | GN31-20W | GN31-29W | GN31-65W | GN31-100W |
| DIMENSIONS: | L325xW175xH20mm | L323.5xW175xH29mm | L325xW175xH65mm | L325xW175xH100mm |
| CASE PACK: | 24pcs | 20pcs | 18pcs | 10pcs |

2/3



| | | | | |
|-------------|-----------------|-----------------|-----------------|-----------------|
| CODE: | GN32-20W | GN32-29W | GN32-40W | GN32-65W |
| DIMENSIONS: | L353xW325xH20mm | L350xW323xH29mm | L353xW325xH40mm | L353xW325xH65mm |
| CASE PACK: | 8pcs | 18pcs | 8pcs | 6pcs |

2/4



| | | | |
|-------------|-----------------|-----------------|-----------------|
| CODE: | GN42-20W | GN42-29W | GN42-65W |
| DIMENSIONS: | L530xW163xH20mm | L528xW161xH29mm | L530xW163xH65mm |
| CASE PACK: | 22pcs | 16pcs | 10pcs |

1/4



| | | | |
|-------------|-----------------|-----------------|------------------|
| CODE: | GN41-29W | GN41-65W | GN41-100W |
| DIMENSIONS: | L264xW161xH29mm | L265xW160xH65mm | L265xW160xH100mm |
| CASE PACK: | 40pcs | 16pcs | 16pcs |

1/6



| | | |
|-------------|-----------------|------------------|
| CODE: | GN61-65W | GN61-100W |
| DIMENSIONS: | L175xW160xH65mm | L175xW160xH100mm |
| CASE PACK: | 44pcs | 28pcs |



| | | |
|-------------|----------------|----------------|
| CODE: | GN11-7B | GN21-7B |
| DIMENSIONS: | L530xW325xH7mm | L325xW260xH7mm |
| CASE PACK: | 12pcs | 24pcs |



| |
|-----------------|
| GN21X2-65W |
| L530xW325xH65mm |
| 4pcs |

DISPLAY RACK



| | |
|-------------|------------------|
| CODE: | MD016 |
| DIMENSIONS: | L550xW580xH325mm |
| CASE PACK: | 6pcs |

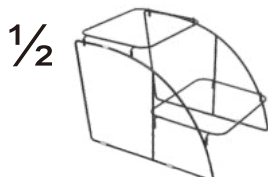

| | |
|-------------|------------------|
| CODE: | MD015 |
| DIMENSIONS: | L520xW390xH325mm |
| CASE PACK: | 6pcs |

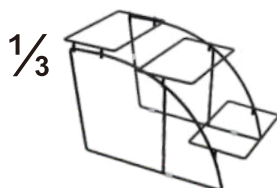

| | |
|-------------|------------------|
| CODE: | MD036 |
| DIMENSIONS: | L520xW340xH315mm |
| CASE PACK: | 6pcs |

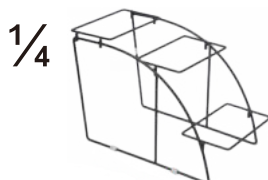

| | |
|-------------|------------------|
| CODE: | MD035 |
| DIMENSIONS: | L520xW275xH315mm |
| CASE PACK: | 6pcs |

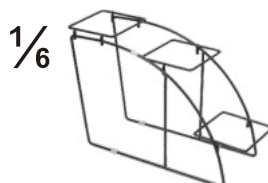

| | |
|-------------|------------------|
| CODE: | MD033 |
| DIMENSIONS: | L520xW190xH320mm |
| CASE PACK: | 8pcs |



COVER (FIT PLATE AND WOOL BASE)



| | | | | |
|-------------|-------------|----------------|----------------|-----------------|
| CODE: | K8720 | TP8720-W | FP8720-W | FP8720-T |
| DIMENSIONS: | H143xD278mm | L264xW264x29mm | L264xW264x29mm | L290xW290xH77mm |
| CASE PACK: | 48pcs | 24pcs | 14pcs | 12pcs |



| | | | | |
|-------------|-------------|----------------|----------------|-----------------|
| CODE: | K8721 | TP8721-W | FP8721-W | FP8721-T |
| DIMENSIONS: | H150xD320mm | L303xW303x29mm | L303xW303x29mm | L330xW330xH77mm |
| CASE PACK: | 48pcs | 22pcs | 12pcs | 12pcs |



| | | | | |
|-------------|-------------|----------------|----------------|-----------------|
| CODE: | K8722 | TP8722-W | FP8722-W | FP8722-T |
| DIMENSIONS: | H160xD373mm | L353xW353x29mm | L353xW353x29mm | L383xW383xH77mm |
| CASE PACK: | 24pcs | 12pcs | 8pcs | 6pcs |



| | | | | |
|-------------|------------------|----------------|----------------|-----------------|
| CODE: | K8723 | TP8723-W | FP8723-W | FP8723-T |
| DIMENSIONS: | L379xW252xH146mm | L360xW233x29mm | L360xW233x29mm | L389xW263xH77mm |
| CASE PACK: | 48pcs | 16pcs | 10pcs | 12pcs |



| | | | | |
|-------------|------------------|----------------|----------------|-----------------|
| CODE: | K8724 | TP8724-W | FP8724-W | FP8724-T |
| DIMENSIONS: | L417xW318xH158mm | L400xW300x29mm | L400xW300x29mm | L428xW330xH77mm |
| CASE PACK: | 24pcs | 16pcs | 12pcs | 8pcs |



| | | | |
|-------------|------------------|----------------|----------------|
| CODE: | K8725 | TP8725-W | FP8725-W |
| DIMENSIONS: | L432xW292xH155mm | L411xW272x29mm | L411xW272x29mm |
| CASE PACK: | 48pcs | 12pcs | 8pcs |



| | |
|-------------|-----------------|
| CODE: | FP8725-T |
| DIMENSIONS: | L440xW300xH77mm |
| CASE PACK: | 8pcs |



| | | | |
|-------------|------------------|----------------|----------------|
| CODE: | K8726 | TP8726-W | FP8726-W |
| DIMENSIONS: | L482xW350xH160mm | L460xW328x29mm | L460xW328x29mm |
| CASE PACK: | 24pcs | 15pcs | 10pcs |



| | |
|-------------|-----------------|
| CODE: | FP8726-T |
| DIMENSIONS: | L490xW360xH77mm |
| CASE PACK: | 6pcs |

BUFFET BARS

Keeps food cold for hours and preserves its taste and freshness.

Food-grade materials with a smooth, crevice-free surface for easy cleaning.

Flip-top cover clearly displays the food inside, achieving a perfect balance between practicality and presentation.

GN1/1



4-Piece Set: 1* Base + 2* Cold Packs + 1*304# Tray + 1*Cover

| CODE | DIMENSIONS | Base | S/S Tray |
|----------|----------------|-------|----------|
| TSW11-11 | L560x352x263mm | WHITE | H11mm |
| TSB11-11 | L560x352x263mm | BLACK | H11mm |
| TSW11-21 | L560x352x263mm | WHITE | H21mm |
| TSB11-21 | L560x352x263mm | BLACK | H21mm |



5-Piece Set: 1* Wood + 1* Base + 2* Cold Packs + 1*304# Tray + 1*Cover

| CODE | DIMENSIONS | Base | S/S Tray |
|----------|----------------|-------|----------|
| TSM11-11 | L610x422x248mm | BLACK | H11mm |
| TSM11-21 | L610x422x248mm | BLACK | H21mm |



double-deck Set: 2* Wood + 2* Base + 2* Cold Packs + 2*304# Tray + 2*Cover + post

| CODE | DIMENSIONS | Base | S/S Tray |
|-----------|----------------|-------|----------|
| TSMD11-11 | L610x422x610mm | BLACK | H11mm |
| TSMD11-21 | L610x422x610mm | BLACK | H21mm |

GN2/3



4-Piece Set: 1* Base +1* Cold Packs+ 1*304# Tray+ 1*Cover

| CODE | DIMENSIONS | Base | S/S Tray |
|----------|----------------|-------|----------|
| TSW32-11 | L382x355x263mm | WHITE | H11mm |
| TSB32-11 | L382x355x263mm | BLACK | H11mm |
| TSW32-21 | L382x355x263mm | WHITE | H21mm |
| TSB32-21 | L382x355x263mm | BLACK | H21mm |



5-Piece Set: 1* Wood+1* Base +1* Cold Packs+1*304# Tray+ 1*Cover

| CODE | DIMENSIONS | Base | S/S Tray |
|----------|----------------|-------|----------|
| TSM32-11 | L438x425x248mm | BLACK | H11mm |
| TSM32-21 | L438x425x248mm | BLACK | H21mm |



double-deck Set: 2* Wood+2* Base +2* Cold Packs+2*304# Tray+ 2*Cover+post

| CODE | DIMENSIONS | Base | S/S Tray |
|-----------|----------------|-------|----------|
| TSMD32-11 | L438x425x610mm | BLACK | H11mm |
| TSMD32-21 | L438x425x610mm | BLACK | H21mm |

15"ROUND



5-Piece Set: 1* Wood+1* Base +1* Cold Packs+1*304# Tray+ 1*Cover

| CODE | DIMENSIONS | Base | S/S Tray |
|----------|----------------|-------|----------|
| TRM15-8 | L483x483x262mm | BLACK | H8mm |
| TRM15-16 | L483x483x262mm | BLACK | H16mm |



Double-deck Set: 2* Wood+2* Base +2* Cold Packs+2*304# Tray+ 2*Cover+post

| CODE | DIMENSIONS | Base | S/S Tray |
|-----------|----------------|-------|----------|
| TRMD15-8 | L483x483x620mm | BLACK | H8mm |
| TRMD15-16 | L483x483x620mm | BLACK | H16mm |

LID



| | |
|-------------|-----------------|
| CODE: | KM15-PCD |
| DIMENSIONS: | L403xW224xH22mm |
| CASE PACK: | 4pcs |

ROUND COVER



6"



7"



8" (PC/PP)



9"

| | | | | |
|-------------|--------------|--------------|-------------------|------------|
| CODE: | K8486 | K8487 | K8439 | K8438 |
| DIMENSIONS: | H60xD160.3mm | H60xD186.4mm | H66xD213mm | H66xD240mm |
| CASE PACK: | 48pcs | 48pcs | PC:48pcs/PP:58pcs | 48pcs |

With handle



9"



10"



11" (PC/PP)



12" (PC/PP)

| | | | | |
|-------------|------------|------------|------------|------------|
| CODE: | KMC9-PC | K8437 | K8436 | K8435 |
| DIMENSIONS: | H67xD239mm | H67xD267mm | H65xD290mm | H70xD317mm |
| CASE PACK: | 72pcs | 24pcs | 24pcs | 24pcs |



14"



16"



18"

| | | | |
|-------------|------------|-------------|---------------|
| CODE: | K8434 | K8488 | K8489 |
| DIMENSIONS: | H86xD368mm | H115xD426mm | H130xD482.5mm |
| CASE PACK: | 24pcs | 24pcs | 24pcs |



OVAL COVER



8"



10"



11"



11" (PC/PP)

| | | | | |
|-------------|-----------------|-----------------|-----------------|-----------------|
| CODE: | K8433 | K8432 | K8431 | KMO811-PC |
| DIMENSIONS: | L208xW155xH65mm | L260xW195xH65mm | L287xW215xH66mm | L280xW209xH67mm |
| CASE PACK: | 80pcs | 48pcs | 24pcs | 72pcs |



12"



14"



16"



18"

| | | | | |
|-------------|-----------------|-----------------|------------------|------------------|
| CODE: | K8430 | K8429 | K8488-1 | K8489-1 |
| DIMENSIONS: | L312xW238xH66mm | L365xW277xH70mm | L430xW315xH103mm | L485xW353xH120mm |
| CASE PACK: | 24pcs | 24pcs | 24pcs | 24pcs |

NON-SLIP TRAYS

- Ideal for patient meal delivery and in high-traffic cafeterias.
- Non-skid surface eliminates the need for tray mats, saving time and money.
- Enhances stability, providing safer transport and service.

NON-SLIP TRAYS Colors: Black Dark Brown

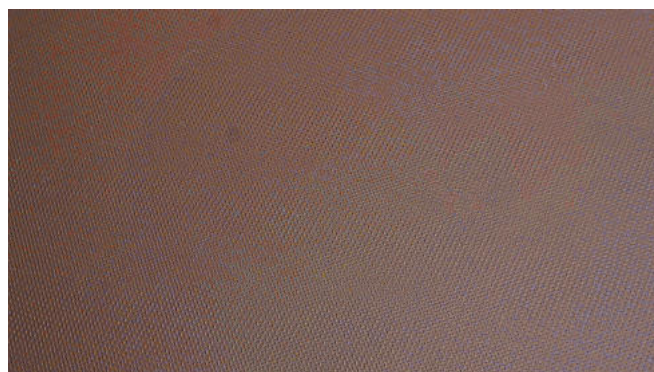

NON-SLIP TRAYS

COLORS:  Black  Dark Brown



| | | |
|-------------|---------------------------|---------------------------|
| CODE: | KD1600A-001 / KD1600A-002 | KD1400A-001 / KD1400A-002 |
| DIMENSIONS: | H21xD405mm | H20xD355mm |
| CASE PACK: | 24pcs | 24pcs |
| MATERIAL: | FIBERGLASS+PP | |



| | | | |
|-------------|----------------------------|----------------------------|----------------------------|
| CODE: | KD2900A-001 KD2900A-002 | KD2700A-001 KD2700A-002 | KD2500A-001 KD2500A-002 |
| DIMENSIONS: | L730xW596xH18mm | L680xW556xH30mm | L623xW517xH25mm |
| CASE PACK: | 10pcs | 12pcs | 12pcs |
| MATERIAL: | FIBERGLASS+PP | | |



| | |
|-------------|---------------------------|
| CODE: | KD1418A-001 / KD1418A-002 |
| DIMENSIONS: | L458xW354xH23mm |
| CASE PACK: | 12pcs |



| | | | | | |
|-------------|----------------------------|----------------------------|----------------------------|----------------------------|----------------------------|
| CODE: | KD1826A-001 KD1826A-002 | KD1625A-001 KD1625A-002 | KD1623A-001 KD1623A-002 | KD1622A-001 KD1622A-002 | KD1520A-001 KD1520A-002 |
| DIMENSIONS: | L632xW452xH32mm | L648xW402xH25mm | L599xW402xH24mm | L555xW402xH23mm | L512xW379xH21mm |
| CASE PACK: | 12pcs | 12pcs | 12pcs | 12pcs | 12pcs |
| MATERIAL: | FIBERGLASS+PP | | | | |

FIBERGLASS TRAY



CODE: KD1014B-012
 DIMENSIONS: L348xW268xH19mm
 CASE PACK: 24pcs



CODE: KD1216B-014
 DIMENSIONS: L418xW308xH19mm
 CASE PACK: 24pcs



CODE: KD1418B-013
 DIMENSIONS: L457xW355xH23mm
 CASE PACK: 12pcs



CODE: KD1520B-016
 DIMENSIONS: L512xW379xH21mm
 CASE PACK: 12pcs



TRAYS

- Provides wood grain and rock grain
Use in restaurants, hotel room service, cafeterias, food courts, schools.
- Stacking keep trays stacked securely in place.
- Material: Fiberglass

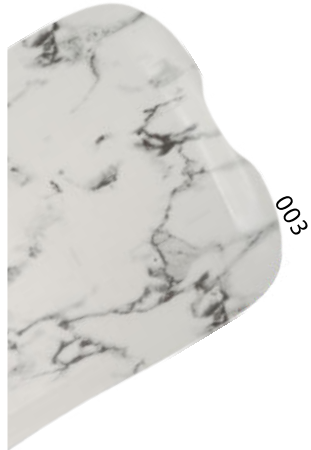

| | |
|-------------|-----------------|
| CODE: | KD1317C-003 |
| DIMENSIONS: | L428xW321xH15mm |
| CASE PACK: | 10pcs |



| | |
|-------------|-----------------|
| CODE: | KD1321C-003 |
| DIMENSIONS: | L528xW320xH15mm |
| CASE PACK: | 14pcs |



| | |
|-------------|-----------------|
| CODE: | KD1317D-009 |
| DIMENSIONS: | L428xW321xH20mm |
| CASE PACK: | 12pcs |



| | |
|-------------|-----------------|
| CODE: | KD1321D-007 |
| DIMENSIONS: | L528xW320xH15mm |
| CASE PACK: | 12pcs |



TRAYS



| | | |
|-------------|-----------------|-----------------|
| CODE: | KD1317F-010 | KD1321F-010 |
| CASE PACK: | 12pcs | 12pcs |
| DIMENSIONS: | L428xW321xH15mm | L528xW321xH15mm |
| MATERIAL: | FIBERGLASS | |



| | |
|-------------|-----------------|
| CODE: | KD1826G |
| MATERIALS: | ABS |
| CASE PACK: | 12pcs |
| DIMENSIONS: | L428xW321xH15mm |

PP TRAY



CODE: KD1014H-G
 DIMENSIONS: L346xW265xH20mm
 CASE PACK: 24pcs



CODE: KD1216H-G
 DIMENSIONS: L409xW300xH20mm
 CASE PACK: 12pcs



CODE: KD1418H-B
 DIMENSIONS: L449xW348xH20mm
 CASE PACK: 12pcs



CODE: KD1217HH-R
 DIMENSIONS: L433xW303xH33mm
 CASE PACK: 12pcs



Red



Dark Green



Black



Enjoyment



BOWLS



CONDIMENT SHAKER



TUMBLERS



GRIP/SPOON/TURNER



PITCHERS



MEASURING CUPS & COVERS





BOWLS(PC)

- Textured on the outside for an elegant look, smooth on the inside for easy cleaning.
- Ideal for fruit, salads, snacks and desserts.

PC (Clear)



PCB (Black)



Bowls are durable and lightweight,
Will not chip and crack like acrylic.



(Ribbed)



| | | | |
|-------------|---------------------|-------------------|--------------------|
| CODE: | KZ1001-912PC | KZ1001-1014PC | KZ1001-1419PC |
| DIMENSIONS: | L308.5xW230xH75.5mm | L369.5xW274xH90mm | L492xW362.5xH120mm |
| CAPACITY: | 2.8L | 5L | 12L |
| CASE PACK: | 48pcs | 24pcs | 12pcs |

Colors: Clear Black



(Ribbed)



| | | | | | | | |
|-------------|----------------|--------------|--------------|-----------------|---------------|---------------|---------------|
| CODE: | KZ2001-6PC | KZ2001-8PC | KZ2001-10PC | KZ2001-12PC | KZ2001-15PC | KZ2001-18PC | KZ2001-23PC |
| DIMENSIONS: | D173.2xH41.2mm | D222.8xH68mm | D275.5xH68mm | D324.8xH100.6mm | D400xH126.8mm | D477xH146.9mm | D605xH190.2mm |
| CAPACITY: | 537ml | 1.54L | 3L | 5.33L | 10.54L | 17.47L | 37.88L |
| CASE PACK: | 96pcs | 48pcs | 48pcs | 12pcs | 8pcs | 4pcs | 4pcs |

Colors: Clear Black



(Pebbled)



| | | | | | | | |
|-------------|----------------|----------------|--------------|----------------|---------------|---------------|---------------|
| CODE: | KZ3001-6PC | KZ3001-8PC | KZ3001-10PC | KZ3001-12PC | KZ3001-15PC | KZ3001-18PC | KZ3001-23PC |
| DIMENSIONS: | D173.2xH38.2mm | D222.8xH64.8mm | D275.5xH79mm | D324.8xH97.6mm | D400xH123.8mm | D477xH143.9mm | D605xH190.2mm |
| CAPACITY: | 537ml | 1.54L | 3L | 5.33L | 10.54L | 17.47L | 37.88L |
| CASE PACK: | 96pcs | 48pcs | 48pcs | 12pcs | 8pcs | 4pcs | 4pcs |

Colors: Clear Black

BOWLS(PC)



| | | | |
|-------------|------------|------------|------------|
| CODE: | K7110 | K7111 | K7112 |
| DIMENSIONS: | H41xD123mm | H44xD143mm | H49xD162mm |
| CAPACITY: | 155ml | 310ml | 485ml |
| CASE PACK: | 192pcs | 168pcs | 144pcs |

MOQ: 500pcs



| | | | |
|-------------|------------|------------|------------|
| CODE: | K7113 | K7114 | K7115 |
| DIMENSIONS: | H53xD182mm | H57xD202mm | H61xD222mm |
| CAPACITY: | 650ml | 815ml | 1000ml |
| CASE PACK: | 96pcs | 72pcs | 48pcs |

MOQ: 500pcs

BOWL



| | | | | |
|-------------|-----------------|---------------------|----------------|----------------------|
| CODE: | BS500B | BS2200B | BS4300B | BS8420B |
| DIMENSIONS: | L127xW127xH59.6 | L203.2xW203.2xH94.6 | L254xW254xH118 | L304.8xW304.8xH141.8 |
| CAPACITY: | 500ml | 2200ml | 4300ml | 8420ml |
| CASE PACK: | 72pcs | 10pcs | 8pcs | 6pcs |



| | | | | |
|-------------|-----------------|---------------------|----------------|----------------------|
| CODE: | BS500W | BS2200W | BS4300W | BS8420W |
| DIMENSIONS: | L127xW127xH59.6 | L203.2xW203.2xH94.6 | L254xW254xH118 | L304.8xW304.8xH141.8 |
| CAPACITY: | 500ml | 2200ml | 4300ml | 8420ml |
| CASE PACK: | 72pcs | 10pcs | 8pcs | 6pcs |

RECTANGULAR BOWL (MELAMINE)



| | | |
|-------------|-----------------|-----------------|
| CODE: | KZ4001-1116MA | KZ4002-1116MA |
| DIMENSIONS: | L416xW284xH22mm | L416xW284xH65mm |
| CASE PACK: | 15pcs | 7pcs |

CONDIMENT SHAKER

- Suit for the condiment station or dining table.
- 4 size holes suit different condiments



CODE: KSF280B
 DIMENSIONS: T108xB70xH95mm
 CAPACITY: 280ml
 CASE PACK: 72pcs



| CODE: | KSF280B1 | KSF280B2 | KSF280B3 | KSF280B4 |
|-------------|----------------|----------------|----------------|----------------|
| DIMENSIONS: | T88xD80xH9.4mm | T88xD80xH9.4mm | T88xD80xH9.4mm | T88xD80xH9.4mm |
| CASE PACK: | 144pcs | 144pcs | 144pcs | 144pcs |
| HOLE DIM. | ∅0.7mm | ∅1.4mm | ∅2.3mm | ∅4.3mm |

GRIP/SPOON/TURNER



| | | | |
|-------------|-------------------|------------------|------------------|
| CODE: | K9071-PC | K9068-PC | K9069-PC |
| DIMENSIONS: | L249xW102.5xH80mm | L290xW119xH109mm | L344xW147xH126mm |
| CASE PACK: | 48pcs | 36pcs | 24pcs |



| | | | |
|-------------|-------------------|------------------|----------------|
| CODE: | K9067-PC | K9065-PP | K9066-PC |
| DIMENSIONS: | L294xW101.5xH71mm | L163xW98xH11.5mm | L173xW66xH50mm |
| CASE PACK: | 48pcs | 12pcs | 48pcs |



| | | |
|-------------|------------------|----------------|
| CODE: | K9070-PC | K0001-SS |
| DIMENSIONS: | L133xW116xH131mm | L165xW60xH20mm |
| CASE PACK: | 96pcs | 72pcs |

TUMBLERS



| | | | | | | | |
|-------------|-------------------|--------------------|--------------------|--------------------|--------------------|--------------------|--------------------|
| CODE: | K8929 | K8928 | K8927 | K8926 | K8925 | K8924 | K8923 |
| DIMENSIONS: | H98xT87xB65xD87mm | H110xT68xB51xD68mm | H123xT70xB54xD70mm | H127xT83xB62xD83mm | H132xT75xB56xD75mm | H138xT85xB64xD85mm | H173xT90xB66xD90mm |
| CAPACITY: | 350ml | 235ml | 285ml | 420ml | 350ml | 460ml | 648ml |
| CASE PACK: | 128pcs | 128pcs | 128pcs | 128pcs | 80pcs | 96pcs | 64pcs |



| | | | | | | | |
|-------------|-------------------|--------------------|--------------------|--------------------|--------------------|--------------------|--------------------|
| CODE: | K8876 | K8875 | K8874 | K8873 | K8872 | K8871 | K8870 |
| DIMENSIONS: | H86xT79xB66xD79mm | H115xT76xB56xD76mm | H125xT79xB57xD79mm | H130xT83xB60xD83mm | H147xT83xB60xD83mm | H155xT85xB61xD85mm | H170xT91xB65xD91mm |
| CAPACITY: | 260ml | 290ml | 350ml | 395ml | 460ml | 490ml | 650ml |
| CASE PACK: | 96pcs | 150pcs | 100pcs | 96pcs | 75pcs | 64pcs | 48pcs |

TUMBLERS



| | | | | | |
|-------------|--------------------|--------------------|--------------------|--------------------|--------------------|
| CODE: | K9318 | K8954 | K8953 | K8952 | K8951 |
| DIMENSIONS: | H109xT69xB54xD69mm | H120xT74xB59xD74mm | H105xT82xB66xD82mm | H150xT79xB63xD79mm | H165xT85xB68xD85mm |
| CAPACITY: | 270ml | 350ml | 365ml | 490ml | 605ml |
| CASE PACK: | 144pcs | 100pcs | 125pcs | 100pcs | 48pcs |



| | | | | | |
|-------------|-------------------|--------------------|--------------------|------------|--------------------|
| CODE: | K8558 | K8559 | K8560 | K9763 | K8561 |
| DIMENSIONS: | H98xT65xB52xD65mm | H110xT70xB53xD70mm | H124xT71xB58xD71mm | D77xH132mm | H145xT80xB58xD80mm |
| CAPACITY: | 220ml | 255ml | 335ml | 390ml | 465ml |
| CASE PACK: | 100pcs | 100pcs | 100pcs | 144pcs | 100pcs |



| | | | | | |
|-------------|-------------------|-------------------|-------------------|-------------------|---------------------|
| CODE: | K8955 | K8934 | K8919 | K8918 | K8917 |
| DIMENSIONS: | H60xT68xB43xD68mm | H70xT75xB46xD75mm | H78xT82xB51xD82mm | H90xT90xB56xD90mm | H115xT94xB59xD114mm |
| CAPACITY: | 105ml | 150ml | 195ml | 290ml | 400ml |
| CASE PACK: | 144pcs | 180pcs | 100pcs | 100pcs | 75pcs |



| | | | |
|-------------|----------------------|----------------------|--------------------|
| CODE: | K8916 | K8915 | K8914 |
| DIMENSIONS: | H130xT100xB62xD100mm | H150xT100xB61xD100mm | H175xT99xB61xD99mm |
| CAPACITY: | 520ml | 590ml | 690ml |
| CASE PACK: | 64pcs | 50pcs | 50pcs |



PITCHERS (PC)



| | | | | |
|-------------|----------------|----------------|----------------|-----------------------|
| CODE: | KH1800A-1PC | KH2800A-1PC | KH4000H-4PC | K8568 |
| DIMENSIONS: | L183xW140xH230 | L214xW173xH277 | L258xW189xH300 | H292xT135xB105xD178mm |
| CAPACITY: | 1.8L | 2.8L | 4.0L | 2L |
| CASE PACK: | 6pcs | 6pcs | 6pcs | 24pcs |



with ice tube



| | | | | |
|-------------|----------------------|-----------------------|-----------------------|-----------------------|
| CODE: | KX047 | KX048 | K9597 | K9598 |
| DIMENSIONS: | H213xT104xB99xD190mm | H258xT134xB120xD225mm | H222xT125xB116xD172mm | H268xT153xB142xD205mm |
| CAPACITY: | 1.8L(With ice tube) | 3.1L(With ice tube) | 1.7L | 3.3L |
| CASE PACK: | 18pcs | 18pcs | 18pcs | 18pcs |



| | | | | | |
|-------------|----------------------|----------------------|----------------------|---------------------|----------------------|
| CODE: | K8578 | K8553 | K8552 | K8551 | K8550 |
| DIMENSIONS: | H184xT140xB94xD182mm | H200xT115xB85xD173mm | H197xT135xB90xD185mm | H268xT75xB85xD100mm | H318xT81xB110xD110mm |
| CAPACITY: | 1.2L | 1.44L | 1.78L | 1092ml | 1500ml |
| CASE PACK: | 24pcs | 18pcs | 18pcs | 32pcs | 32pcs |



MEASURING CUPS & COVERS

Note: All graduations are approximate.

GATBO
German Technology

40°C-99°C

PRODUCT: _____

REMARK: _____

DATE: _____ TEMPERATURE: _____

The label is wipeable and repetition

| | | |
|------------------------|------------------|------------------|
| | | |
| CODE: KHB-2PC | KH500B-PC | KH500B-2PC |
| DIMENSIONS: D108xH15mm | L139xW100xH120mm | L139xW108xH125mm |
| CAPACITY: \ | 500ml | 500ml |
| CASE PACK: 96pcs | 48pcs | 48pcs |

| | | |
|------------------------|------------------|------------------|
| | | |
| CODE: KHC-2PC | KH1000C-PC | KH1000C-2PC |
| DIMENSIONS: D130xH15mm | L163xW123xH155mm | L162xW131xH162mm |
| CAPACITY: \ | 1L | 1L |
| CASE PACK: 96pcs | 48pcs | 12pcs |

| | | |
|------------------------|------------------|------------------|
| | | |
| CODE: KHD-2PC | KH2000D-PC | KH2000D-2PC |
| DIMENSIONS: D157xH15mm | L191xW150xH217mm | L193xW157xH222mm |
| CAPACITY: \ | 2L | 2L |
| CASE PACK: 96pcs | 12pcs | 12pcs |

| | | |
|------------------------|------------------|------------------|
| | | |
| CODE: KHE-2PC | KH3000E-PC | KH3000E-2PC |
| DIMENSIONS: D179xH18mm | L217xW167xH245mm | L219xW175xH250mm |
| CAPACITY: \ | 3L | 3L |
| CASE PACK: 96pcs | 12pcs | 12pcs |

| | | |
|------------------------|------------------|------------------|
| | | |
| CODE: KHF-2PC | KH2000F-PC | KH2000F-2PC |
| DIMENSIONS: D195xH19mm | L235xW184xH162mm | L233xW193xH168mm |
| CAPACITY: \ | 2L | 2L |
| CASE PACK: 96pcs | 12pcs | 18pcs |

| | | |
|------------------------|------------------|------------------|
| | | |
| CODE: KHF-2PC | KH4000F-PC | KH4000F-2PC |
| DIMENSIONS: D195xH19mm | L240xW183xH264mm | L243xW193xH270mm |
| CAPACITY: \ | 4L | 4L |
| CASE PACK: 96pcs | 12pcs | 12pcs |

| | | |
|------------------------|------------------|------------------|
| | | |
| CODE: KHG-2PC | KH5000G-PC | KH5000G-2PC |
| DIMENSIONS: D207xH18mm | L253xW195xH282mm | L255xW206xH300mm |
| CAPACITY: \ | 5L | 5L |
| CASE PACK: 96pcs | 12pcs | 6pcs |

| |
|---------------------------|
| |
| CODE: KH225A-PC |
| DIMENSIONS: L95xW69xH79mm |
| CAPACITY: 225ml |
| CASE PACK: 96pcs |



Clean



UTILITY CARTS



UTILITY CARTS



TRASH CAN



CUP RACKS



TROLLEYS



UTILITY CARTS

- Multi-functional, durable and economically-priced carts for various uses.
- Lightly-textured polypropylene shelves keep contents in place, each layer can bear a weight 50kg.
- Waterproof, durable and easy to clean.
- Silent casters with brakes, move quietly, floor-friendly, and stop at any time without sliding.
- Easy to assemble.



CODE: KVD1-3
 MATERIALS: PP
 DIMENSIONS: L895xW485xH979mm
 CASE PACK: 1pcs



CODE: KVD1-4
 MATERIALS: PP
 DIMENSIONS: L757xW485xH1209mm
 CASE PACK: 1pcs



CODE: KVD1-5
 MATERIALS: PP
 DIMENSIONS: L757xW485xH1546mm
 CASE PACK: 1pcs



CODE: KVD2-3
 MATERIALS: PP
 DIMENSIONS: L1042xW586xH979mm
 CASE PACK: 1pcs



CODE: KVD2-4
 MATERIALS: PP
 DIMENSIONS: L904xW586xH1207mm
 CASE PACK: 1pcs



CODE: KVD2-5
 MATERIALS: PP
 DIMENSIONS: L904xW586xH1544mm
 CASE PACK: 1pcs



CODE: KVD1-4A
 MATERIALS: PP
 DIMENSIONS: L757xW485xH1209mm
 CASE PACK: 1pcs



CODE: KVD1-5A
 MATERIALS: PP
 DIMENSIONS: L757xW485xH1546mm
 CASE PACK: 1pcs



CODE: KVD2-4A
 MATERIALS: PP
 DIMENSIONS: L904xW586xH1207mm
 CASE PACK: 1pcs



CODE: KVD2-5A
 MATERIALS: PP
 DIMENSIONS: L904xW586xH1544mm
 CASE PACK: 1pcs



| | | |
|-------------|------------------|-------------------|
| CODE: | KVD1-3A | KVD2-3A |
| MATERIALS: | PP | PP |
| DIMENSIONS: | L895xW485xH979mm | L1042xW586xH979mm |
| CASE PACK: | 1pcs | 1pcs |

UTILITY CARTS WITH PANELS



| | | |
|-------------|----------------|----------------|
| CODE: | KVD3-3 | KVD3-3A |
| MATERIALS: | KVD3-3 | KVD3-3A |
| DIMENSIONS: | 1090x540x960mm | 1090x540x960mm |
| CASE PACK: | 1pcs | 1pcs |

Rustproof construction



Sturdy aluminum post



Lockable design for secure closure, preventing door self-opening.



Double-Layer Baffle for Flexible Food Arrangement



Never Rusts

Plastic castors, safe, durable, quiet and never rust.

BOXES

The material and design are made for the foodservice industry—where non-stop use and quick cleaning are must-haves!

1. Made of PE material and stands up to daily heavy use.
2. Easy to clean and carry—ideal for the fast-paced hustle of a busy kitchen.



| | | | |
|-------------|-----------------|------------------|------------------|
| CODE: | KVD-2115PEB | KVD-21157PEB | KVD-21155PEB |
| DIMENSIONS: | L545XW397XH26mm | L535XW384XH180mm | L535XW384XH128mm |
| CASE PACK: | 24pcs | 6pcs | 6pcs |



| | | |
|-------------|------------------|------------------|
| CODE: | KVD-P1 | KVD-P2 |
| DIMENSIONS: | L335xW309*H555mm | L335xW309*H267mm |
| CASE PACK: | 4pcs | 6pcs |



TRASH CAN



Sealable Lid Design: Keeps out dirt and bad smells, makes kitchens and public areas clean and improves your hotel's image.

Dual Handle Design: Easy to carry and lift, no pain on hands when emptying trash, saves cleaning time.

Wheel-equipped Base: Light and quiet to move, will not damage floors, easy to move in lobbies, hallways and kitchens.



| | | | | |
|------------|------------------|------------------|------------------|------------------|
| CODE: | KT35-G | KT80-G | KT120-G | KT170-G |
| DIMENSIONS | L470xW391xH446mm | L563xW510xH580mm | L559xW627xH700mm | L690xW610xH803mm |
| CAPACITY: | 35L | 80L | 120L | 170L |
| CASE PACK | 6PCS | 6PCS | 6PCS | 4PCS |



| | | | | |
|-------------|-------------------|-------------------|-------------------|-----------------|
| CODE: | KT-1G | KT-2G | KT-3G | KT-4G |
| DIMENSIONS: | L458xW405xH35.5mm | L569xW514xH35.5mm | L627xW572xH35.5mm | L680xW620xH47mm |
| CASE PACK: | 18PCS | 12PCS | 12PCS | 12PCS |



| | | | |
|------------|------------------|-----------------|----------------|
| CODE: | KT200-G | KT-5G | KT-D |
| DIMENSIONS | L790xW675xH840mm | L740xW682xH46mm | D458.9xH98.7mm |
| CAPACITY: | 200L | | |
| CASE PACK | 3PCS | 9PCS | 1PCS |

FULL SIZE CUP RACK (PP)

GATBO German Technology BPA free 40°C+95°C

PRODUCT _____

REMARK _____ USE NOT-USED

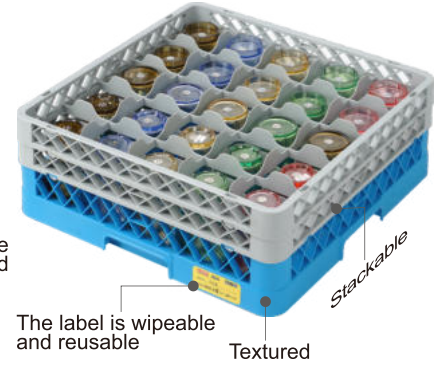
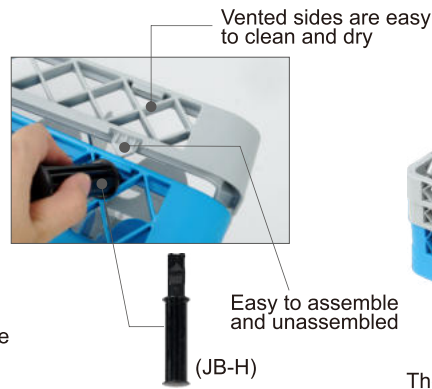
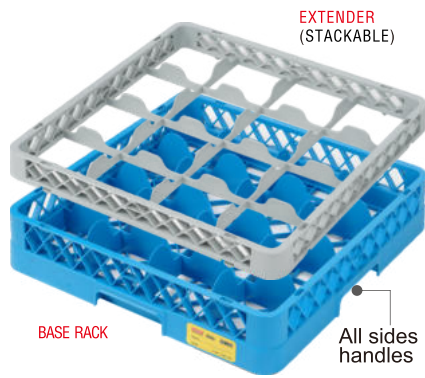

The label is wipeable and repetition



9 COMPARTMENTS

| CODE | DIMENSIONS | MAXIMUM HEIGHT | AVAILABLE HEIGHT | CASE PACK |
|-------|--------------------|----------------|------------------|-----------|
| JB-92 | L49.5xW49.5xH5.5cm | 5.5cm | 4.3cm | 12pcs |
| JB-9 | L50xW50xH10cm | 10.0cm | 9.0cm | 6pcs |

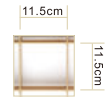

16 COMPARTMENTS

| CODE | DIMENSIONS | MAXIMUM HEIGHT | AVAILABLE HEIGHT | CASE PACK |
|--------|--------------------|----------------|------------------|-----------|
| JB-162 | L49.5xW49.5xH5.5cm | 5.0cm | 4.5cm | 12pcs |
| JB-16 | L50xW50xH10cm | 10.0cm | 9.0cm | 6pcs |

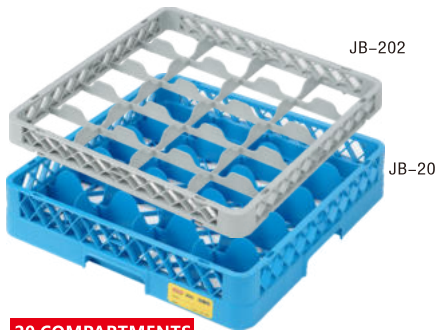

20 COMPARTMENTS

| CODE | DIMENSIONS | MAXIMUM HEIGHT | AVAILABLE HEIGHT | CASE PACK |
|--------|--------------------|----------------|------------------|-----------|
| JB-202 | L49.5xW49.5xH5.5cm | 5.0cm | 4.5cm | 12pcs |
| JB-20 | L50xW50xH10cm | 10.0cm | 9.0cm | 6pcs |

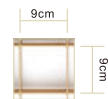

25 COMPARTMENTS

| CODE | DIMENSIONS | MAXIMUM HEIGHT | AVAILABLE HEIGHT | CASE PACK |
|--------|--------------------|----------------|------------------|-----------|
| JB-252 | L49.5xW49.5xH5.5cm | 5.0cm | 4.5cm | 12pcs |
| JB-25 | L50xW50xH10cm | 10.0cm | 9.0cm | 6pcs |

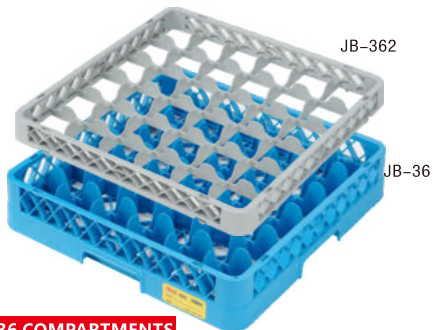

36 COMPARTMENTS

| CODE | DIMENSIONS | MAXIMUM HEIGHT | AVAILABLE HEIGHT | CASE PACK |
|--------|--------------------|----------------|------------------|-----------|
| JB-362 | L49.5xW49.5xH5.5cm | 5.0cm | 4.5cm | 12pcs |
| JB-36 | L50xW50xH10cm | 10.0cm | 9.0cm | 6pcs |

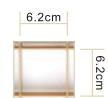

49 COMPARTMENTS

| CODE | DIMENSIONS | MAXIMUM HEIGHT | AVAILABLE HEIGHT | CASE PACK |
|--------|--------------------|----------------|------------------|-----------|
| JB-492 | L49.5xW49.5xH5.5cm | 5.0cm | 4.5cm | 12pcs |
| JB-49 | L50xW50xH10cm | 10.0cm | 9.0cm | 6pcs |



FULL SIZE CUP RACK SET

CODE:JB-9+3

Base Rack
compartment quantity



Extender quantity.

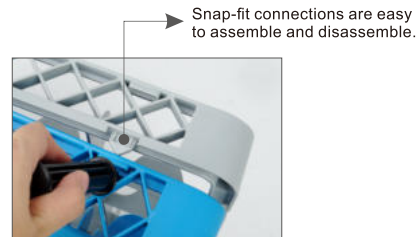

WITH 1 EXTENDER

| CODE | DIMENSIONS | CASE PACK | GROSS WEIGHT |
|---------|---------------|-----------|--------------|
| JB-9+1 | L49xW49xH14cm | 6pcs | 11.40kgs |
| JB-16+1 | L49xW49xH14cm | 6pcs | 11.99kgs |
| JB-20+1 | L49xW49xH14cm | 6pcs | 12.16kgs |
| JB-25+1 | L49xW49xH14cm | 6pcs | 13.25kgs |
| JB-36+1 | L49xW49xH14cm | 6pcs | 14.14kgs |
| JB-49+1 | L49xW49xH14cm | 6pcs | 14.90kgs |



WITH 2 EXTENDERS

| CODE | DIMENSIONS | CASE PACK | GROSS WEIGHT |
|---------|---------------|-----------|--------------|
| JB-9+2 | L49xW49xH18cm | 4pcs | 12.64kgs |
| JB-16+2 | L49xW49xH18cm | 4pcs | 13.26kgs |
| JB-20+2 | L49xW49xH18cm | 4pcs | 13.46kgs |
| JB-25+2 | L49xW49xH18cm | 4pcs | 14.82kgs |
| JB-36+2 | L49xW49xH18cm | 4pcs | 15.83kgs |
| JB-49+2 | L49xW49xH18cm | 4pcs | 16.61kgs |



WITH 3 EXTENDERS

| CODE | DIMENSIONS | CASE PACK | GROSS WEIGHT |
|---------|---------------|-----------|--------------|
| JB-9+3 | L49xW49xH22cm | 3pcs | 13.25kgs |
| JB-16+3 | L49xW49xH22cm | 3pcs | 13.88kgs |
| JB-20+3 | L49xW49xH22cm | 3pcs | 14.10kgs |
| JB-25+3 | L49xW49xH22cm | 3pcs | 15.60kgs |
| JB-36+3 | L49xW49xH22cm | 3pcs | 16.67kgs |
| JB-49+3 | L49xW49xH22cm | 3pcs | 17.46kgs |



WITH 4 EXTENDERS

| CODE | DIMENSIONS | CASE PACK | GROSS WEIGHT |
|---------|---------------|-----------|--------------|
| JB-9+4 | L49xW49xH26cm | 3pcs | 16.84kgs |
| JB-16+4 | L49xW49xH26cm | 3pcs | 17.65kgs |
| JB-20+4 | L49xW49xH26cm | 3pcs | 17.93kgs |
| JB-25+4 | L49xW49xH26cm | 3pcs | 19.91kgs |
| JB-36+4 | L49xW49xH26cm | 3pcs | 21.30kgs |
| JB-49+4 | L49xW49xH26cm | 3pcs | 22.28kgs |

FULL SIZE RACK & TRAY RACK (PP)



25 PEG RACK



25 OPEN END TRAY RACK



JB-25B
 DIMENSIONS:L500xW500xH100mm
 CASE PACK: 6pcs



JB-25P
 DIMENSIONS:L500xW500xH100mm
 CASE PACK: 6pcs

32 PEG RACK



JB-32B
 DIMENSIONS:L500xW500xH100mm
 CASE PACK: 6pcs

32 OPEN END TRAY RACK



JB-32P
 DIMENSIONS:L500xW500xH100mm
 CASE PACK: 6pcs

49 PEG RACK



JB-49B
 DIMENSIONS:L500xW500xH100mm
 CASE PACK: 6pcs

49 OPEN END TRAY RACK



JB-49P
 DIMENSIONS:L500xW500xH100mm
 CASE PACK: 6pcs

64 PEG RACK



JB-64B
 DIMENSIONS:L500xW500xH100mm
 CASE PACK: 6pcs

64 OPEN END TRAY RACK



JB-64P
 DIMENSIONS:L500xW500xH100mm
 CASE PACK: 6pcs

FULL SIZE CUP RACK (PP)



Base Rack



JB-S

DIMENSIONS: L500xW500xH100mm

CASE PACK: 6pcs

Full Flatware Rack



JB-C

DIMENSIONS: L500xW500xH100mm

CASE PACK: 6pcs



Open Extender

JB-P

DIMENSIONS: L500xW500xH102mm

OVERALL DIM.: 5.9cm (Inside dim.: 3.5cm)

CASE PACK: 12pcs



JB-H

DIMENSIONS: D25xH127mm

CASE PACK: 100pcs

FULL SIZE CUP RACK



Snap-fit connections are easy to assemble and disassemble.



Use the cover to protect the contents.



Prevents liquid flow-out

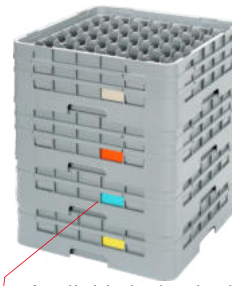

Available in 4 color label options



Stackable



16 COMPARTMENTS

| | CODE | DIMENSIONS | MAXIMUM HEIGHT | CASE PACK |
|--------------------------------|------------|------------------|----------------|-----------|
| HALF DROP COMPARTMENT EXTENDER | BK-L016A | L500xW500xH80mm | 4cm | 12pcs |
| FULL DROP COMPARTMENT EXTENDER | BK-L002-16 | L500xW500xH120mm | 4cm | 12pcs |
| BASE RACK | BK-L002 | L504xW504xH102mm | 7cm | 6pcs |

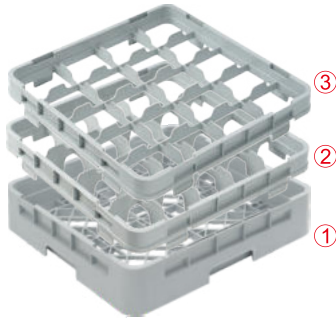

20 COMPARTMENTS

| | CODE | DIMENSIONS | MAXIMUM HEIGHT | CASE PACK |
|--------------------------------|------------|------------------|----------------|-----------|
| HALF DROP COMPARTMENT EXTENDER | BK-L020A | L500xW500xH80mm | 4cm | 12pcs |
| FULL DROP COMPARTMENT EXTENDER | BK-L002-20 | L500xW500xH120mm | 4cm | 12pcs |
| BASE RACK | BK-L002 | L504xW504xH102mm | 7cm | 6pcs |

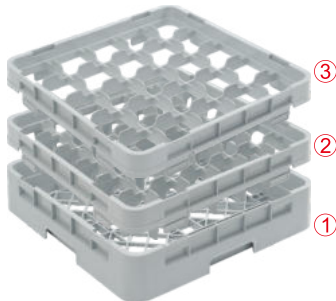

25 COMPARTMENTS

| | CODE | DIMENSIONS | MAXIMUM HEIGHT | CASE PACK |
|--------------------------------|------------|------------------|----------------|-----------|
| HALF DROP COMPARTMENT EXTENDER | BK-L025A | L500xW500xH80mm | 4cm | 12pcs |
| FULL DROP COMPARTMENT EXTENDER | BK-L002-25 | L500xW500xH120mm | 4cm | 12pcs |
| BASE RACK | BK-L002 | L504xW504xH102mm | 7cm | 6pcs |

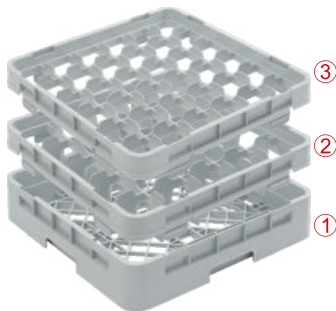

36 COMPARTMENTS

| | CODE | DIMENSIONS | MAXIMUM HEIGHT | CASE PACK |
|--------------------------------|------------|------------------|----------------|-----------|
| HALF DROP COMPARTMENT EXTENDER | BK-L036A | L500xW500xH80mm | 4cm | 12pcs |
| FULL DROP COMPARTMENT EXTENDER | BK-L002-36 | L500xW500xH120mm | 4cm | 12pcs |
| BASE RACK | BK-L002 | L504xW504xH102mm | 7cm | 6pcs |

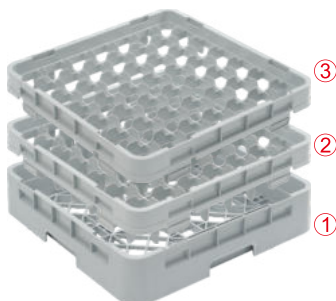

49 COMPARTMENTS

| | CODE | DIMENSIONS | MAXIMUM HEIGHT | CASE PACK |
|--------------------------------|------------|------------------|----------------|-----------|
| HALF DROP COMPARTMENT EXTENDER | BK-L049A | L500xW500xH80mm | 4cm | 12pcs |
| FULL DROP COMPARTMENT EXTENDER | BK-L002-49 | L500xW500xH120mm | 4cm | 12pcs |
| BASE RACK | BK-L002 | L504xW504xH102mm | 7cm | 6pcs |

FULL SIZE CUP RACK



16 COMPARTMENTS



| | CODE | DIMENSIONS | MAXIMUM HEIGHT | CASE PACK |
|--------------------------------|----------|------------------|----------------|-----------|
| HALF DROP COMPARTMENT EXTENDER | BK-L016A | L500xW500xH80mm | 4cm | 12pcs |
| BASE RACK WITH COMPARTMENT | BK-L016 | L504xW504xH102mm | 7cm | 6pcs |



20 COMPARTMENTS



| | CODE | DIMENSIONS | MAXIMUM HEIGHT | CASE PACK |
|--------------------------------|----------|------------------|----------------|-----------|
| HALF DROP COMPARTMENT EXTENDER | BK-L020A | L504xW504xH81mm | 4cm | 12pcs |
| BASE RACK WITH COMPARTMENT | BK-L020 | L513xW513xH103mm | 10.2cm | 6pcs |



25 COMPARTMENTS



| | CODE | DIMENSIONS | MAXIMUM HEIGHT | CASE PACK |
|--------------------------------|----------|------------------|----------------|-----------|
| HALF DROP COMPARTMENT EXTENDER | BK-L025A | L500xW500xH80mm | 4cm | 12pcs |
| BASE RACK WITH COMPARTMENT | BK-L025 | L504xW504xH102mm | 7cm | 6pcs |



36 COMPARTMENTS



| | CODE | DIMENSIONS | MAXIMUM HEIGHT | CASE PACK |
|--------------------------------|----------|------------------|----------------|-----------|
| HALF DROP COMPARTMENT EXTENDER | BK-L036A | L500xW500xH80mm | 4cm | 12pcs |
| BASE RACK WITH COMPARTMENT | BK-L036 | L504xW504xH102mm | 7cm | 6pcs |

FULL SIZE PEG RACK



5X9 PEG RACK

| | |
|-------------|------------------|
| CODE: | ZDK-L032 |
| DIMENSIONS: | L504xW504xH102mm |
| CASE PACK: | 6pcs |



9X9 PEG RACK

| | |
|-------------|------------------|
| CODE: | ZDK-L064 |
| DIMENSIONS: | L504xW504xH102mm |
| CASE PACK: | 6pcs |



9X9 OPEN END TRAY RACK

| | |
|-------------|------------------|
| CODE: | ZDK-L064P |
| DIMENSIONS: | L504xW504xH102mm |
| CASE PACK: | 6pcs |



FULL FLATWARE RACK

| | |
|-------------|------------------|
| CODE: | BK-L001 |
| DIMENSIONS: | L504xW504xH102mm |
| CASE PACK: | 6pcs |



BASE RACK

| | |
|-------------|------------------|
| CODE: | BK-L002 |
| DIMENSIONS: | L504xW504xH102mm |
| CASE PACK: | 6pcs |

HALF SIZE CUP RACK

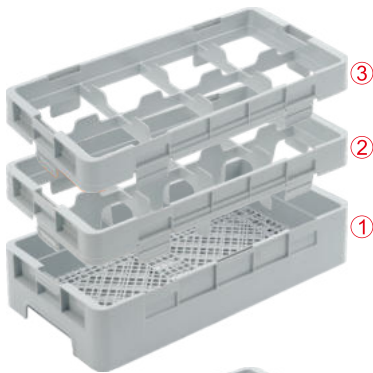

8 COMPARTMENTS

| | CODE | DIMENSIONS | MAXIMUM HEIGHT | AVAILABLE HEIGHT | CASE PACK |
|--------------------------------|----------|------------------|----------------|------------------|-----------|
| HALF DROP COMPARTMENT EXTENDER | BK-D008A | L509xW250xH81mm | 8cm | 4cm | 12pcs |
| FULL DROP COMPARTMENT EXTENDER | BK-D008 | L509xW250xH127mm | 12cm | 4cm | 12pcs |
| BASE RACK | BK-D001 | L513xW250xH103mm | 10.2cm | 7cm | 6pcs |

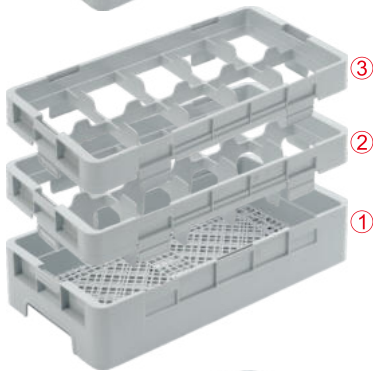

10 COMPARTMENTS

| | CODE | DIMENSIONS | MAXIMUM HEIGHT | AVAILABLE HEIGHT | CASE PACK |
|--------------------------------|----------|------------------|----------------|------------------|-----------|
| HALF DROP COMPARTMENT EXTENDER | BK-D010A | L509xW250xH81mm | 8cm | 4cm | 12pcs |
| FULL DROP COMPARTMENT EXTENDER | BK-D010 | L509xW250xH127mm | 12cm | 4cm | 12pcs |
| BASE RACK | BK-D001 | L513xW250xH103mm | 10.2cm | 7cm | 6pcs |

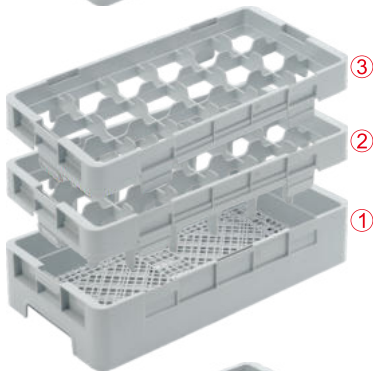

18 COMPARTMENTS

| | CODE | DIMENSIONS | MAXIMUM HEIGHT | AVAILABLE HEIGHT | CASE PACK |
|--------------------------------|----------|------------------|----------------|------------------|-----------|
| HALF DROP COMPARTMENT EXTENDER | BK-D018A | L509xW250xH81mm | 8cm | 4cm | 12pcs |
| FULL DROP COMPARTMENT EXTENDER | BK-D018 | L509xW250xH127mm | 12cm | 4cm | 12pcs |
| BASE RACK | BK-D001 | L513xW250xH103mm | 10.2cm | 7cm | 6pcs |

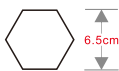
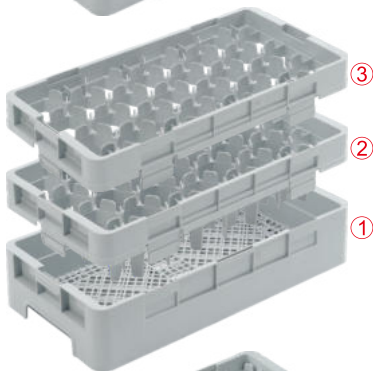

24 COMPARTMENTS

| | CODE | DIMENSIONS | MAXIMUM HEIGHT | AVAILABLE HEIGHT | CASE PACK |
|--------------------------------|----------|------------------|----------------|------------------|-----------|
| HALF DROP COMPARTMENT EXTENDER | BK-D024A | L509xW250xH81mm | 8cm | 4cm | 12pcs |
| FULL DROP COMPARTMENT EXTENDER | BK-D024 | L509xW250xH112mm | 12cm | 4cm | 12pcs |
| BASE RACK | BK-D001 | L513xW250xH103mm | 10.2cm | 7cm | 6pcs |



32 COMPARTMENTS

| | CODE | DIMENSIONS | MAXIMUM HEIGHT | AVAILABLE HEIGHT | CASE PACK |
|--------------------------------|----------|------------------|----------------|------------------|-----------|
| HALF DROP COMPARTMENT EXTENDER | BK-D032A | L509xW250xH81mm | 8cm | 4cm | 12pcs |
| FULL DROP COMPARTMENT EXTENDER | BK-D032 | L509xW250xH112mm | 12cm | 4cm | 12pcs |
| BASE RACK | BK-D001 | L513xW250xH103mm | 10.2cm | 7cm | 6pcs |



| | | |
|-------------|------------------|------------------|
| CODE: | BK-D001 | BK-D002 |
| DIMENSIONS: | L513xW250xH103mm | L513xW250xH103mm |
| CASE PACK: | 6pcs | 6pcs |

HALF FLAT WARE BASKET

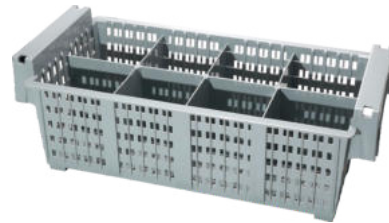
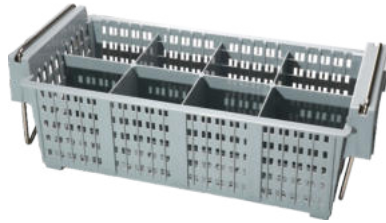
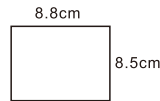
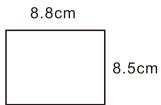

| | | |
|-------------|------------------------|--------------------|
| CODE: | K9758-1 (With handles) | K9758 (No handles) |
| DIMENSIONS: | L427xW208xH147mm | L427xW208xH147mm |
| CASE PACK: | 10pcs | 10pcs |



TROLLEYS

- Trolley creates a portable sanitary storage system.
- Quiet swivel casters ensure smooth and stable transport.



| | |
|----------------------|------------------|
| CODE: | K-RTG |
| MATERIALS: | PP |
| EXTERIOR DIMENSIONS: | L520xW520xH110mm |
| INTERIOR DIMENSIONS: | L350xW350xH50mm |
| CASE PACK: | 1pcs |
| LOAD CAPACITY: | 50kg |
| CASTERS: | 4 SWIVEL |

K-RT2
Stainless steel handle



Assembly packaging

GATBO



JB PRODUCTS FACTORY LIMITED

 No.3, Meifeng Street, Guzhen,
Zhongshan, Guangdong, China

 GATBO@jbtableware.com